

PRODUCT MANUAL

Frontier[®] 400X / Frontier[®] 400X Pipe



For use with Product/Code
Numbers:

12716, 12717, 12781, 13202

Save for future reference

Date Purchased

Code: (ex: 10859)

Serial: (ex: U1060512345)

Contents

INSTALLATION..... SECTION A

GENERAL DESCRIPTION.....	A-1
TECHNICAL SPECIFICATIONS.....	A-1
SAFETY PRECAUTIONS.....	A-3
VOLTAGE REDUCTION DEVICE (VRD).....	A-4
LOCATION AND VENTILATION.....	A-5
STORING.....	A-5
STACKING.....	A-5
ANGLE OF OPERATION.....	A-5
LIFTING.....	A-5
ENVIRONMENTAL LIMITATIONS.....	A-6
HIGH ALTITUDE OPERATION.....	A-6
HIGH TEMPERATURE OPERATION.....	A-6
COLD WEATHER STARTING.....	A-6
TOWING.....	A-7
SERVICE TRUCK AND TRAILER INSTALLATION.....	A-7
PRE_OPERATION ENGINE SERVICE.....	A-8
OIL.....	A-8
FUEL.....	A-8
ENGINE COOLING SYSTEM.....	A-8
BATTERY CONNECTION.....	A-9
EXHAUST OUTLET PIPE.....	A-10
SPARK ARRESTOR.....	A-10
AIR CLEANER SERVICE INDICATOR.....	A-10
MACHINE GROUNDING.....	A-10
AUXILIARY POWER RECEPTACLES.....	A-11
120 VAC DUPLEX RECEPTACLE AND GFCI.....	A-12
CIRCUIT BREAKERS.....	A-12
ELECTRICAL DEVICE USE.....	A-12
WELDING OUTPUT CABLES.....	A-12
CABLE INSTALLATION.....	A-13
CABLE INDUCTANCE AND ITS EFFECT ON WELDING.....	A-13
CROSSLINK TECHNOLOGY.....	A-15
REMOTE CONTROL CONNECTIONS.....	A-15
REMOTE OUTPUT CONTROL.....	A-15
REMOTE WELD TERMINALS.....	A-15
ACCESSORY CONNECTION DIAGRAMS.....	A-15
CROSSLINK WIRE FEEDER SETUP EXAMPLE.....	A-16
CROSSLINK REMOTE SETUP EXAMPLE.....	A-16
DUAL ARC SETUP EXAMPLE.....	A-17
TIG SETUP WITH FOOT PEDAL EXAMPLE.....	A-17

OPERATION..... SECTION B

ADDITIONAL SAFETY PRECAUTIONS.....	B-1
RECOMMENDED APPLICATIONS.....	B-2
ADDING FUEL.....	B-2
BREAK-IN PERIOD.....	B-3
ENGINE OPERATION.....	B-3
STARTING THE ENGINE.....	B-3
STOPPING THE ENGINE.....	B-3

TYPICAL FUEL CONSUMPTION.....	B-4
SYSTEM CONTROLS.....	B-5
USER INTERFACE CONTROLS.....	B-7
HOME SCREEN.....	B-8
WELD MODE SCREEN WELD SETTINGS.....	B-9
WELD MODE SCREEN ENGINE INDICATORS.....	B-10
ACTIVE WELD SCREEN.....	B-10
WELD MODE SETTINGS.....	B-11
WELD MODE SETTINGS REMOTE.....	B-11
WELD MODE SETTINGS HOT START.....	B-12
WELD MODE SETTINGS ARC FORCE.....	B-12
WELD MODE SETTING WELD TERMINALS.....	B-13
WELD MODE SETTINGS MEMORY.....	B-13
ENGINE STATUS SCREEN.....	B-14
SETTING SCREEN.....	B-16
MANAGING RESTRICTIONS.....	B-17
AUTO-STOP/START.....	B-18
MEMORY MODE OPERATION.....	B-19
PRODUCTIVITY METRICS.....	B-20
CROSSLINC TECHNOLOGY.....	B-21
DUTY CYCLE.....	B-21
PARALLELING.....	B-21
ARC GOUGING MODE.....	B-21
STICK (SMAW).....	B-22
TIG (GTAW).....	B-22
FLUX - CORED SELF - SHIELDED WIRE (FCAW - S), SELF - SHIELD GAS - SHIELDED WIRE (FCAW - G), AND MIG (GMAW) MODES.....	B-22
PIPE (SMAW) MODE.....	B-23
AUXILIARY POWER OPERATION.....	B-23
SIMULTANEOUS WELDING AND AUXILIARY POWER LOADS.....	B-23

ACCESSORIES AND OPTIONS..... SECTION C

CROSSLINC ACCESSORIES.....	C-1
GENERAL ACCESSORIES.....	C-1
SERVICE KITS.....	C-2
REMOTE CONTROLS.....	C-2
TIG ACCESSORIES.....	C-3
WIRE FEEDER AND GUNS.....	C-4
CABLE ACCESSORIES.....	C-4
POWER SOURCES.....	C-4

MAINTENANCE..... SECTION D

SAFETY PRECAUTIONS.....	D-1
ROUTINE AND PERIODIC MAINTENANCE.....	D-2
ENGINE MAINTENANCE.....	D-3
AIR FILTER.....	D-3
AIR FILTER SERVICE INSTRUCTIONS.....	D-4
FUEL FILTERS.....	D-6
COOLING SYSTEM.....	D-6
CHECKING AND REPLACING COOLANT.....	D-7
BATTERY HANDLING.....	D-7
ENGINE OIL CHANGE.....	D-9

TIGHTENING THE FAN BELT.....	D-9
NAMEPLATES/WARNING DECALS MAINTENANCE.....	D-9
GFCI MODULE.....	D-10
ENGINE SERVICE KUBOTA D1503-M.....	D-11
ENGINE SERVICE PERKINS 403F-15T.....	D-13

TROUBLESHOOTING..... SECTION E

HOW TO USE TROUBLESHOOTING GUIDE.....	E-1
FUNCTIONAL PROBLEMS - ENGINE.....	E-1
FUNCTIONAL PROBLEMS GENERAL.....	E-3

GRAPHIC SYMBOL DESCRIPTIONS

RETEST AFTER REPAIR

DIMENSIONS

SCHEMATIC DIAGRAMS

WIRING DIAGRAMS

CUSTOMER ASSISTANCE POLICY

SAFETY INFORMATION

SAFETY DEPENDS ON YOU

Lincoln welding and cutting equipment is designed and built with safety in mind. However, your overall safety can be increased by proper installation ... and thoughtful operation on your part. **DO NOT INSTALL, OPERATE OR REPAIR THIS EQUIPMENT WITHOUT READING THIS MANUAL AND THE SAFETY PRECAUTIONS CONTAINED THROUGHOUT.** And, most importantly, think before you act and be careful.

 DANGER	
	This statement indicates an imminently hazardous situation which, if not avoided, will result in death or serious injury.

 WARNING	
	This statement indicates a potentially hazardous situation which, if not avoided, could result in death or serious injury.

 CAUTION	
	This statement indicates a potentially hazardous situation which, if not avoided, could result in minor or moderate injury.

Notice: This statement indicates the possibility of damage to equipment if the potential risk is not avoided.

PLEASE EXAMINE CARTON AND EQUIPMENT FOR DAMAGE IMMEDIATELY

When this equipment is shipped, title passes to the purchaser upon receipt by the carrier. Consequently, claims for material damaged in shipment must be made by the purchaser against the transportation company at the time the shipment is received.

KEEP YOUR HEAD OUT OF THE FUMES



- **DON'T** get too close to the weld. Use corrective lenses if necessary to stay a reasonable distance away from the weld.
- **USE ENOUGH VENTILATION** or exhaust at the weld, or both, to keep the fumes and gases from your breathing zone and the general area.
- **IN A LARGE ROOM OR OUTDOORS**, natural ventilation may be adequate if you keep your head out of the fumes.
- **USE NATURAL DRAFTS** or fans to keep the fumes away from your face.
- **READ** and obey the Safety Data Sheet (SDS) and the warning label that appears on all containers of welding materials.

If you develop unusual symptoms, see your supervisor. Perhaps the welding atmosphere and ventilation system should be checked.

WEAR CORRECT EYE, EAR AND BODY PROTECTION



- **PROTECT** your eyes and face with properly fitted and with proper grade of filter plate (See ANSI Z49.1).
- **PROTECT** your body from welding spatter and arc flash with protective clothing including woolen clothing, flame-proof apron and gloves, leather leggings, and high boots.
- **PROTECT** others from spatter, flash, and glare with protective screens or barriers.
- **PROTECT** your eyes and face with welding helmet
- **IN SOME AREAS**, protection from noise may be appropriate.
- **BE SURE** protective equipment is in good condition.
- **AT ALL TIMES**, wear safety glasses in work area.



- **DO NOT WELD OR CUT** containers or materials which previously had been in contact with hazardous substances unless they are properly cleaned. This is extremely dangerous.



SAFETY INFORMATION



- **DO NOT WELD OR CUT** painted or plated parts unless special precautions with ventilation have been taken. They can release highly toxic fumes or gases.
- **PROTECT** compressed gas cylinders from excessive heat, mechanical shocks, and arcs; fasten cylinders so they cannot fall.
- **BE SURE** cylinders are never grounded or part of an electrical circuit.
- **REMOVE** all potential fire hazards from welding area.



- **ALWAYS HAVE FIRE FIGHTING EQUIPMENT READY FOR IMMEDIATE USE AND KNOW HOW TO USE IT.**

CALIFORNIA PROPOSITION 65 WARNINGS

 WARNING	
	<p>Breathing diesel engine exhaust exposes you to chemicals known to the State of California to cause cancer and birth defects, or other reproductive harm.</p> <p>Always start and operate the engine in a well-ventilated area.</p> <p>If in an exposed area, vent the exhaust to the outside.</p> <p>Do not modify or tamper with the exhaust system.</p> <p>Do not idle the engine except as necessary.</p>

 WARNING	
	<p>This product, when used for welding or cutting, produces fumes or gases which contain chemicals known to the State of California to cause birth defects and, in some cases, cancer. (California Health & Safety Code § 25249.5 et seq.)</p>

For more information go to <https://www.p65warnings.ca.gov>

ARC WELDING CAN BE HAZARDOUS

PROTECT YOURSELF AND OTHERS FROM POSSIBLE SERIOUS INJURY OR DEATH. KEEP CHILDREN AWAY. PACEMAKER WEARERS SHOULD CONSULT WITH THEIR DOCTOR BEFORE OPERATING.

Read and understand the following safety highlights. For additional safety information, it is strongly recommended that you purchase a copy of "Safety in Welding & Cutting - ANSI Standard Z49.1" from the American Welding Society, P.O. Box 351040, Miami, Florida 33135 or CSA Standard W117.2. A Free copy of "Arc Welding Safety" booklet E205 is available from the Lincoln Electric Company, 22801 St. Clair Avenue, Cleveland, Ohio 44117-1199.

BE SURE THAT ALL INSTALLATION, OPERATION, MAINTENANCE AND REPAIR PROCEDURES ARE PERFORMED ONLY BY QUALIFIED INDIVIDUALS.

FOR ENGINE POWERED EQUIPMENT



- Turn the engine off before troubleshooting and maintenance work unless the maintenance work requires it to be running.



- Do not add the fuel near an open flame welding arc or when the engine is running. Stop the engine and allow it to cool before refueling to prevent spilled fuel from vaporizing on contact with hot engine parts and igniting. Do not spill fuel when filling tank. If fuel is spilled, wipe it up and do not start engine until fumes have been eliminated.



- Keep all equipment safety guards, covers and devices in position and in good repair. Keep hands, hair, clothing and tools away from V-belts, gears, fans and all other moving parts when starting, operating or repairing equipment.

- In some cases it may be necessary to remove safety guards to perform required maintenance. **REMOVE GUARDS ONLY** when necessary and replace them when the maintenance requiring their removal is complete. Always use the greatest care when working near moving parts.
- **DO NOT** put your hands near the engine fan. Do not attempt to override the governor or idler by pushing on the throttle control rods while the engine is running.
- To prevent accidentally starting gasoline engines while turning the engine or welding generator during maintenance work, disconnect the spark plug wires, distributor cap or magneto wire as appropriate.



- To avoid scalding, do not remove the radiator pressure cap when the engine is hot.



- Generator exhaust contains carbon monoxide. This is a poison you cannot see or smell.
- Using a generator indoors **CAN KILL YOU IN MINUTES**.
- **NEVER** use inside a home or garage, **EVEN IF** doors and windows are open.
- **ONLY** use **OUTSIDE** and far away from windows, doors and vents.



- Avoid other generator hazards. **READ MANUAL BEFORE USE.**

ELECTRIC AND MAGNETIC FIELDS MAY BE DANGEROUS



- Electric current flowing through any conductor causes localized Electric and Magnetic Fields (EMF). Welding current creates EMF fields around welding cables and welding machines.
- EMF fields may interfere with some pacemakers, and welders having a pacemaker should consult their physician before welding.
- Exposure to EMF fields in welding may have other health effects which are now not known. All welders should use the following procedures in order to minimize exposure to EMF fields from the welding circuit:
 - Route the electrode and work cables together - Secure them with tape when possible.

- Never coil the electrode lead around your body.
- Do not place your body between the electrode and work cables. If the electrode cable is on your right side, the work cable should also be on your right side.
- Connect the work cable to the workpiece as close as possible to the area being welded.
- Do not work next to welding power source.

ELECTRIC SHOCK CAN KILL



- The electrode and work (or ground) circuits are electrically "hot" when the welder is on. Do not touch these "hot" parts with your bare skin or wet clothing. Wear dry, hole-free gloves to insulate hands.
- Insulate yourself from work and ground using dry insulation. Make certain the insulation is large enough to cover your full area of physical contact with work and ground.

In addition to the normal safety precautions, if welding must be performed under electrically hazardous conditions (in damp locations or while wearing wet clothing; on metal structures such as floors, gratings or scaffolds; when in cramped positions such as sitting, kneeling or lying, if there is a high risk of unavoidable or accidental contact with the workpiece or ground) use the following equipment:

- Semiautomatic DC Constant Voltage (Wire) Welder.
- DC Manual (Stick) Welder.
- AC Welder with Reduced Voltage Control.
- In semiautomatic or automatic wire welding, the electrode, electrode reel, welding head, nozzle or semiautomatic welding gun are also electrically "hot".
- Always be sure the work cable makes a good electrical connection with the metal being welded. The connection should be as close as possible to the area being welded.
- Ground the work or metal to be welded to a good electrical (earth) ground.
- Maintain the electrode holder, work clamp, welding cable and welding machine in good, safe operating condition. Replace damaged insulation.
- Never dip the electrode in water for cooling.

SAFETY INFORMATION

- Never simultaneously touch electrically “hot” parts of electrode holders connected to two welders because voltage between the two can be the total of the open circuit voltage of both welders.
- When working above floor level, use a safety belt to protect yourself from a fall should you get a shock.
- **Also see [WELDING AND CUTTING SPARKS CAN CAUSE FIRE OR EXPLOSION](#) and [FOR ELECTRICALLY POWERED EQUIPMENT](#)**

ARC RAYS CAN BURN



- Use a shield with the proper filter and cover plates to protect your eyes from sparks and the rays of the arc when welding or observing open arc welding. Headshield and filter lens should conform to ANSI Z87.1 standards.
- Use suitable clothing made from durable flame-resistant material to protect your skin and that of your helpers from the arc rays.
- Protect other nearby personnel with suitable, non-flammable screening and/or warn them not to watch the arc nor expose themselves to the arc rays or to hot spatter or metal.

FUMES AND GASES CAN BE DANGEROUS



- Welding may produce fumes and gases hazardous to health. Avoid breathing these fumes and gases. When welding, keep your head out of the fume. Use enough ventilation and/or exhaust at the arc to keep fumes and gases away from the breathing zone.
- **When welding hardfacing (see instructions on container or SDS) or on lead or cadmium plated steel and other metals or coatings which produce highly toxic fumes, keep exposure as low as possible and within applicable OSHA PEL and ACGIH TLV limits using local exhaust or mechanical ventilation unless exposure assessments indicate otherwise. In confined spaces or in some circumstances, outdoors, a respirator may**

also be required. Additional precautions are also required when welding on galvanized steel.

- The operation of welding fume control equipment is affected by various factors including proper use and positioning of the equipment, maintenance of the equipment and the specific welding procedure and application involved. Worker exposure level should be checked upon installation and periodically thereafter to be certain it is within applicable OSHA PEL and ACGIH TLV limits.
- Do not weld in locations near chlorinated hydrocarbon vapors coming from degreasing, cleaning or spraying operations. The heat and rays of the arc can react with solvent vapors to form phosgene, a highly toxic gas, and other irritating products.
- Shielding gases used for welding can displace air and cause injury or death. Always use enough ventilation, especially in confined areas, to insure breathing air is safe.
- Read and understand the manufacturer’s instructions for this equipment and the consumables to be used, including the Safety Data Sheet (SDS) and follow your employer’s safety practices. SDS forms are available from your welding distributor or from the manufacturer.
- Also see [FOR ENGINE POWERED EQUIPMENT](#)

WELDING AND CUTTING SPARKS CAN CAUSE FIRE OR EXPLOSION



- Remove fire hazards from the welding area. If this is not possible, cover them to prevent the welding sparks from starting a fire. Remember that welding sparks and hot materials from welding can easily go through small cracks and openings to adjacent areas. Avoid welding near hydraulic lines. Have a fire extinguisher readily available.
- Where compressed gases are to be used at the job site, special precautions should be used to prevent hazardous situations. Refer to “**Safety in Welding and Cutting**” (ANSI Standard Z49.1) and the operating information for the equipment being used.

- When not welding, make certain no part of the electrode circuit is touching the work or ground. Accidental contact can cause overheating and create a fire hazard.
- Do not heat, cut or weld tanks, drums or containers until the proper steps have been taken to ensure that such procedures will not cause flammable or toxic vapors from substances inside. They can cause an explosion even though they have been “cleaned”. For information, purchase “Recommended Safe Practices for the Preparation for Welding and Cutting of Containers and Piping That Have Held Hazardous Substances”, **AWS F4.1** from the American Welding Society.
- Vent hollow castings or containers before heating, cutting or welding. They may explode.
- Sparks and spatter are thrown from the welding arc. Wear oil free protective garments such as leather gloves, heavy shirt, cuff-less trousers, high shoes and a cap over your hair. Wear ear plugs when welding out of position or in confined places. Always wear safety glasses with side shields when in a welding area.
- Connect the work cable to the work as close to the welding area as practical. Work cables connected to the building framework or other locations away from the welding area increase the possibility of the welding current passing through lifting chains, crane cables or other alternate circuits. This can create fire hazards or overheat lifting chains or cables until they fail.
- **Read and follow NFPA 51B** “Standard for Fire Prevention During Welding, Cutting and Other Hot Work”, available from NFPA, 1 Batterymarch Park, PO box 9101, Quincy, MA 02269-9101.
- **DO NOT** use a welding power source for pipe thawing.

CYLINDER MAY EXPLODE IF DAMAGED



- Use only compressed gas cylinders containing the correct shielding gas for the process used and properly operating regulators designed for the gas and pressure used. All hoses, fittings, etc. should be suitable for the application and maintained in good condition.

- Always keep cylinders in an upright position securely chained to an undercarriage or fixed support.

Cylinders should be located:

- Away from areas where they may be struck or subjected to physical damage.
- A safe distance from arc welding or cutting operations and any other source of heat, sparks, or flame.
- Never allow the electrode, electrode holder or any other electrically “hot” parts to touch a cylinder.
- Keep your head and face away from the cylinder valve outlet when opening the cylinder valve.
- Valve protection caps should always be in place and hand tight except when the cylinder is in use or connected for use.
- Read and follow the instructions on compressed gas cylinders, associated equipment, and CGA publication P-1, “Precautions for Safe Handling of Compressed Gases in Cylinders,” available from the Compressed Gas Association, 14501 George Carter Way Chantilly, VA 20151.

FOR ELECTRICALLY POWERED EQUIPMENT



- Turn off input power using the disconnect switch at the fuse box before working on the equipment.
- Install equipment in accordance with the U.S. National Electrical Code, all local codes and the manufacturer’s recommendations.
- Ground the equipment in accordance with the U.S. National Electrical Code and the manufacturer’s recommendations.

BATTERY HANDLING, STORAGE, AND DISPOSAL



Batteries can be flammable substances such as lithium or other organic solvents, which may result in overheating, rupture, or combustion. Failure to follow the battery manufactures instructions may result in fire, personal injury, and damage to property if used improperly.

SAFETY INFORMATION

- DO NOT short circuit, disassemble, deform, or heat batteries.
- DO NOT attempt to recharge batteries unless they are specifically marked as "rechargeable".
- DO NOT use or charge the battery if it appears to be leaking, deformed or damaged in any way.
- Store in a cool location. Keep batteries away from direct sunlight, high temperature, and high humidity.
- Immediately discontinue use of the battery if, while using, charging, or storing the battery, the battery emits an unusual smell, feels hot, changes color, changes shape, or appears abnormal in any other way.
- Keep batteries out of reach of children, should a child swallow a battery, consult a physician immediately.
- Recycle or dispose of batteries in accordance with local and federal laws.
- All persons inside LCA must wear proper PPE to avoid eye or skin exposure to laser radiation. The end user's LSO shall select proper PPE including, but not limited to, heat-resistant gloves, flame-resistant clothing, laser safety eye wear and laser-safe helmets that conform to ANSI Z136.1 Optical Density requirements for the wavelength and output power of the laser in use. Standard safety glasses and welding helmets DO NOT provide adequate protection from laser beam hazards. Always inspect PPE for damage or improper fit before use.
- Only qualified persons shall install, operate or service this unit per ANSI Z136.1 standards and your LSO's instruction. Read and follow all labels and manuals before installing, operating, or servicing hand held any laser welding equipment.
- Do not operate outside of a LCA, or if the laser protective housing is modified or damaged, or if safety interlocks have been bypassed or otherwise defeated. Inspect all equipment and LCA for damage or tampering prior to use.
- Reflected beams from the laser can damage eyes and skin and can pose a fire risk. Prior to use, the LCA should be assessed by the LSO to understand the surfaces where hazardous reflected beams can exist. Never position yourself or flammable material in the anticipated laser beam path and take extra precautions when working on reflective materials like aluminum and stainless steel.
- Follow all standards, individual facility or building regulations, and national, state, and local codes.

FOR LASER EMITTING EQUIPMENT



- Hazardous Class 4 (IV) laser products emit invisible, infrared laser radiation which can permanently damage the eye's retina and/or cornea, burn skin, and pose a fire risk. End users shall assign a qualified Laser Safety Officer (LSO) who has the certifications required by applicable law/standards, have a documented Laser Safety Program and have a Laser Controlled Area (LCA) that confirms to ANSI Z136.1 & Z136.9.
- Do not operate laser before end user's LSO has completed a risk assessment and all the prescribed Risk Mitigations measures have been fully implemented. Ensure the laser is operated/demonstrated safely by trained personnel and that the environment surrounding the laser welding cell or laser-controlled area is safe for people nearby when the laser is in operation.
- Never point the laser at yourself or others. Never look directly into a laser aperture, even if wearing full eye protection.

DEALER LOCATOR & PRODUCT REGISTRATION

Register your machine:



<https://www.lincolnelectric.com/register>

Authorized Service and Distributor Locator:

<https://www.lincolnelectric.com/locator>

ADDITIONAL SAFETY INFORMATION

Refer to <http://www.lincolnelectric.com/safety> for additional safety information

INSTALLATION

GENERAL DESCRIPTION

The FRONTIER 400X is a diesel engine driven welding power source. The machine features DC multi-process welding plus power. The welding control system uses state of the art Chopper Technology® for superior welding performance. The machine utilizes a robust 7" graphical user interface display for simplified controls and advanced features

The machine has been equipped with Crossline® Technology to provide weld cable communication for voltage control at the arc without the need for a control cable.

TECHNICAL SPECIFICATIONS

INPUT - DIESEL ENGINE	
MAKE / MODEL	DESCRIPTION
Perkins® 403F-15T EPA Tier 4 Final Compliant (K3484-1, K3485-1)	Cylinder, 24.7 HP (18.4 kW) Turbocharged Water Cooled Diesel Engine
CAPACITIES	DISPLACEMENT
Fuel: 20 US gal. (75.7L) Oil: 6.40 qts. (6.0L) Radiator Coolant: 7.20 qts. (6.8L)	91.0 cu. in. (1.5L) Bore / Stroke 3.30" x 3.50" 84mm x 90mm
MAKE / MODEL	DESCRIPTION
Kubota® D1503-MEPA Tier 4 Final Compliant (K3484-2, K3485-2)	Cylinder, 24.8 HP (18.5 kW), Water Cooled, Diesel Engine
CAPACITIES	DISPLACEMENT
Fuel: 20 US gal. (75.7L) Oil: 5.90 qts. (5.6L) Radiator Coolant: 7.20 qts. (6.8L)	91.0 cu. in. (1.5L) Bore / Stroke 3.27" x 3.64" 83mm x 92.4mm
STARTING SYSTEM	SPEED (RPM)
12 VDC Battery and Starter Manual Glow Plugs	High Idle 1800 Low Idle 1440 Full Load 1800
BATTERY SIZE	
BCI Group Size 34 650 Cold Crank Amps	

RATED WELDING OUTPUT @ 104 °F (40°C)		
DUTY CYCLE	WELDING OUTPUT	VOLTAGE
100%	325 Amps(DC multi-purpose)	33 Volts
60%	400 Amps (DC multi-purpose)	26 Volts

OUTPUT @104°F (40°C) - WELDER AND GENERATOR	
WELDING MODE	OUTPUT RANGE

INSTALLATION

OUTPUT @104°F (40°C) - WELDER AND GENERATOR	
Stick (SMAW)	30-400 Amps
Flux-Cored Self-Shielded (FCAW-S)	10 to 45 Volts
MIG (GMAW)	10 to 45 Volts
Flux-Cored Gas-Shielded (FCAW-G)	10 to 45 Volts
Arc Gouging (CAC-A)	60-400 Amps
DC TIG (GTAW)	5-400 Amps
Pipe (SMAW)**	30-400 Amps
**Only available on Frontier 400X Pipe model	
Open Circuit Voltage 60 VDC Avg @1800 RPM 71 VDC Peak @1800 RPM	
Auxiliary Power ⁽¹⁾ 120 V / 240 V, 60 Hz 10,000 Watts Continuous / 11,500 Watts Peak, Single Phase 11,000 Watts Continuous / 12,500 Watts Peak, Three Phase	

RECEPTACLES		
RECEPTACLE	QUANTITY	CIRCUIT BREAKER
120 VAC Duplex (5-20R) GFCI Protected	2	20 Amps
240 VAC Three Phase (15-50R)	1	50 Amps
120/240 VAC Single Phase (14-50R)	1	50 Amps

AGENCY APPROVALS & STANDARDS	
CONFORMITY MARK	CSA
INGRESS PROTECTION RATING	IP23S
IEC STANDARD	60974-1

ENGINE DETAILS	
ENGINE DETAILS	GOVERNOR
Tier 4 Final Compliant	Electronic
AIR CLEANER	ENGINE IDLER
Single Element	Automatic Idler
FUEL SYSTEM	
Mechanical Fuel Pump with Auto Air Bleed System	
Electric Shutoff Solenoid	
Indirect Fuel Injector	
MUFFLER	ENGINE PROTECTION
Low Noise Muffler with Rotating Exhaust Tube and Internal USFS Certified Spark Arrestor	Low Oil Pressure Shutdown High Engine Coolant Temperature
ENGINE WARRANTY INFORMATION	Perkins (www.perkins.com) Kubota (www.kubotaengine.com)

PHYSICAL DIMENSIONS	
Height ⁽²⁾	35.94 in. (913 mm)
Width ⁽³⁾	25.30 in. (643 mm)
Depth	60.00 in. (1524 mm)
Weight ⁽⁴⁾	1035 lbs. (469 kg)

Note: ⁽¹⁾ Output rating in watts is equivalent to volt-amperes at unity power factor. Output voltage is within +/- 10% at all loads up to rated capacity. When welding, available auxiliary power will be reduced.



Note: ⁽²⁾ Top of Enclosure. Add 7.9" (200 mm) for exhaust.



Note: ⁽³⁾ Includes Door. Base is 24.0" (610 mm) wide.



Note: ⁽⁴⁾ Approximate weight less fuel.

SAFETY PRECAUTIONS

Do not attempt to use this equipment until you have thoroughly read all operating and maintenance manuals supplied with your machine. They include important safety precautions, detailed engine starting, operating and maintenance instructions and parts lists.

 WARNING	
	<p>ELECTRIC SHOCK can kill.</p> <ul style="list-style-type: none"> • Do not touch electrically live parts such as output terminals or internal wiring • Insulate yourself from the work and ground. • Always wear dry insulating gloves.

 WARNING	
	<p>ENGINE EXHAUST can kill.</p> <ul style="list-style-type: none"> • Use in open, well ventilated areas or vent exhaust outside

 WARNING	
	<p>MOVING PARTS can injure.</p> <ul style="list-style-type: none"> • Do not operate with doors open or guards off. • Stop engine before servicing • Keep away from moving parts

Only qualified personnel should install, use, or service this equipment.

VOLTAGE REDUCTION DEVICE (VRD)

The VRD reduces the OCV (Open Circuit Voltage) at the welding output terminals while not welding to less than 30 VDC when the resistance of the output circuit is above 200Ω (ohms).

The VRD requires that the welding cable connections be kept in good electrical condition because poor connections will contribute to poor starting. Having good electrical connections also limits the possibility of other safety issues such as heat-generated damage, burns, and fire

This machine has two VRD switches to allow VRD to be switched "ON" or "OFF" in CC modes, CV modes, or both. The machine is shipped with both VRD switches in the "OFF" position.

To utilize the CrossLinc feature on this product, the VRD needs to be switched "OFF" for the given output type.

To turn VRD "ON" or "OFF":

- Turn the engine "OFF"
- Disconnect the negative battery cable
- Lower the front panel by removing 4 mounting screws

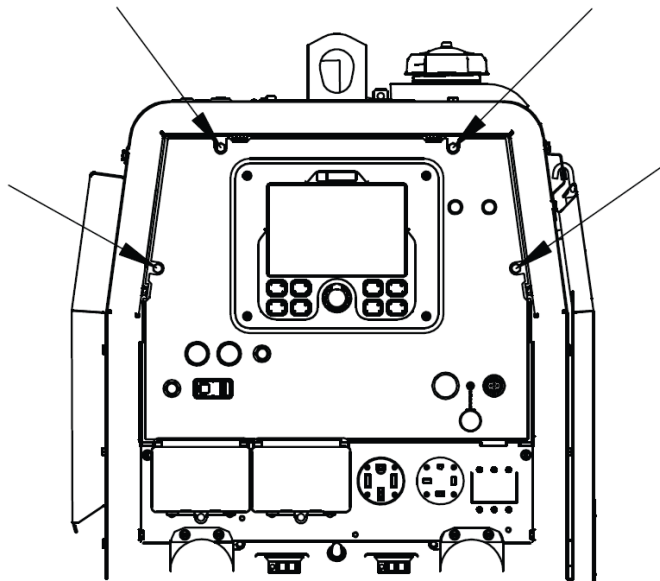

- Place the VRD switches in the "ON" or "OFF" position

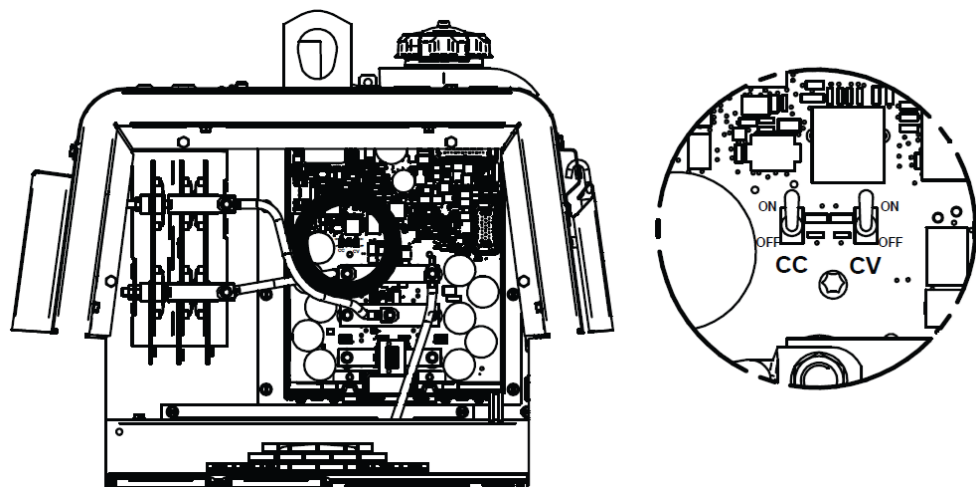

LOCATION AND VENTILATION

The FRONTIER 400X should be located to provide an unrestricted flow of clean, cool air to the cooling air inlets and to avoid restricting the cooling air outlets. Also, locate the welder so that the engine exhaust fumes are properly vented to an outside area.

WARNING



Air to cool the engine is drawn in the front and side and exhausted through radiator and case back. It is important that the intake and exhaust air is not restricted. Allow a minimum clearance of 1ft. (0.6m) from the case back and 16 in. (406mm) from either side of the base to a vertical surface. (Failure to resolve these guidelines may result in an overtemp condition resulting in engine shut down.)

WARNING



DO NOT MOUNT OVER COMBUSTIBLE SURFACES

Where there is a combustible surface directly under stationary or fixed electrical equipment, that surface should be covered with a steel plate at least .06”(1.6mm) thick, which should extend not less than 5.90”(150mm) beyond the equipment on all sides.

STORING

1. Store the machine in a cool, dry place when it is not in use. Protect it from dust and dirt. Keep it where it can't be accidentally damaged from construction activities, moving vehicles, and other hazards.
2. Drain the engine oil and refill with fresh oil. Run the engine for about five minutes to circulate oil to all parts. See the ENGINE OPERATION section manual for details on changing oil.
3. Remove the battery, recharge it, and adjust the electrolyte level. Store the battery in a dry, dark place.

STACKING



FRONTIER 400X machines cannot be stacked.

ANGLE OF OPERATION

To achieve optimum engine performance the FRONTIER 400X should be run in a level position. The maximum angle of continuous operation for the Perkins engine is 25° in all directions, 35° intermittent (less than 10 minutes continuous) in all directions. The Kubota engine is 20° and 30°, respectively. When operating the welder at an angle, provisions must be made for checking and maintaining the oil level at the normal (FULL) oil capacity. Also the effective fuel capacity will be slightly less than the specified 20 gal. (75.5L).

LIFTING

The FRONTIER 400X weighs approximately 1174 lbs. (533kg) with a full tank of fuel and 1035 lbs. (469kg) less fuel. A lift bale is mounted to the machine and should always be used when lifting the machine.

 WARNING	
	<p>FALLING EQUIPMENT can cause injury.</p> <ul style="list-style-type: none">• Lift only with equipment of adequate lifting capacity.• Be sure machine is stable when lifting.• Do not lift this machine using lift bale if it is equipped with a heavy accessory such as trailer or gas cylinder.• Do not lift machine if lift bale is damaged.• Do not operate machine while suspended from lift bale.

ENVIROMENTAL LIMITATIONS

This machine is IP23S rated for use in an outdoor environment. The machine should not be subjected to falling water during use nor should any parts of it be submerged in water. Doing so may cause improper operation as well as pose a safety hazard. The best practice is to keep the machine in a dry, sheltered area.

HIGH ALTITUDE OPERATION

At higher altitudes, output derating may be necessary.

Perkins: For maximum rating, derate the welder output 2% for every 1000 ft. (305 m) above 5000 ft. (1524 m).

Kubota: For maximum rating, derate the welder output 4% for every 984 ft. (300 m) above 4920 ft. (1500 m).

Contact an Authorized Service Representative for any engine adjustments that may be required.

HIGH TEMPERATURE OPERATION

At temperatures above 104°F (40°C), output voltage derating may be necessary. For maximum output current ratings, derate welder voltage rating 2 volts for every 21°F (10°C) above 104°F (40°C).

COLD WEATHER STARTING

With a fully charged battery and OW-40 oil, the engine should start satisfactorily down to -5°F (-20°C). If the engine must be frequently started at or below 0°F (-18°C), it may be desirable to install cold-starting aides. For engines with common rail injection, the mixing of petroleum or kerosene and adding of extra low additives is not permissible. Fuels in accordance with ASTM S975 Grade 1D or DIN EN590-Arctic-Diesel may have no petroleum added. Allow the engine to warm up before applying a load or switching to high idle.

 WARNING	
	<p>Under no conditions should ether or other starting fluids be used with this engine!</p>

TOWING

Use a recommended trailer for use with this equipment for road, in-plant and yard towing by a vehicle(1). If the user adapts a non-Lincoln trailer, they must assume responsibility that the method of attachment and usage does not result in a safety hazard or damage the welding equipment. Some of the factors to be considered are as follows:

1. Design capacity of trailer vs. weight of Lincoln equipment and likely additional attachments.
2. Proper support of, and attachment to, the base of the welding equipment so there will be no undue stress to the framework.
3. Proper placement of the equipment on the trailer to ensure stability side to side and front to back when being moved and when standing by itself while being operated or serviced.
4. Typical conditions of use, i.e., travel speed; roughness of surface on which the trailer will be operated; environmental conditions; like maintenance.
5. Conformance with federal, state and local laws.(1)

Note: (1) Consult applicable federal, state and local laws regarding specific requirements for use on public highways.

SERVICE TRUCK AND TRAILER INSTALLATION

The FRONTIER 400X should be located to provide an unrestricted flow of clean, cool air to the cooling air inlets and to avoid heated air coming out of the welder recirculating back to the cooling air inlet. Also, locate the welder so that engine exhaust fumes are properly vented to an outside area.

WARNING



- Improperly mounted concentrated loads may cause unstable vehicle handling and tires or other components to fail.
- Only transport this welding equipment on serviceable vehicles which are rated and designed for such loads.
- Distribute, balance and secure loads so vehicle is stable under conditions of use.
- Do not exceed maximum rated loads for components such as suspension, axles and tires.
- Mount equipment base to metal bed or frame of vehicle. Do not mount the welder using rubber mounts.
- Follow vehicle manufacturer's instructions.
- Do not install equipment where air flow is restricted. Equipment or the engine may overheat.
- Do not weld on the base. Welding on the base may cause fuel tank explosion or fire.
- Always ground the equipment frame to the vehicle frame to prevent electric shock and static electricity hazards.
- Do not place propane or shielding gas tanks near hot air or exhaust.

PRE_OPERATION ENGINE SERVICE

READ the engine operating and maintenance instructions supplied with this machine.

WARNING



- Stop engine and allow to cool before fueling.
- Do not smoke when fueling.
- Fill fuel tank at a moderate rate and do not overfill
- Wipe up spilled fuel and allow fumes to clear before starting engine.
- Keep sparks and flame away from tank

OIL

The FRONTIER 400X is shipped with the engine crankcase filled with high quality SAE 10W-30 Oil that meets (API class CJ-4 or better) for diesel engines. Check the oil level before starting the engine. If it is not up to the full mark on the dip stick, add oil as required. The oil change interval is dependent on the quality of the oil and the operating environment. Refer to the Engine Operator's Manual for more details on specific oil recommendations, break-in information, and proper service and maintenance intervals.

FUEL

WARNING



USE ULTRA-LOW SULFUR DIESEL FUEL IN US AND CANADA

Fill the fuel tank with clean, fresh fuel. The capacity of the tank is 20 gal. (75.7L). When the fuel gauge reads empty the tank contains approximately 2 gal. (7.6L) of reserve fuel.

NOTE: A fuel shut off valve is located just before the pre-filter/sediment filter. Place the valve in the closed position when the welder is not used for extended periods of time.

ENGINE COOLING SYSTEM

WARNING



HOT COOLANT can burn skin.
Do not remove cap if radiator is hot.

The FRONTIER 400X is shipped with the engine and radiator filled with a 50% mixture of ethylene glycol and water. See the MAINTENANCE section and the engine Operator's Manual for more information on coolant.

BATTERY CONNECTION**⚠ CAUTION**

Use caution as the electrolyte is a strong acid that can burn skin and damage eyes.

The FRONTIER 400X is shipped with the negative battery cable disconnected. Make certain that the RUN/ STOP/IDLE switch is in the STOP position. Remove the four screws from the battery tray using a screwdriver or a 3/8"(10mm) socket. Attach the negative battery cable to the negative battery terminal and tighten using a 1/2"(13mm) socket or wrench

NOTE: This machine is furnished with a wet charged battery; if unused for several months, the battery may require a booster charge. Be careful to charge the battery with the correct polarity. (See Battery in MAINTENANCE section)

⚠ WARNING

GASES FROM BATTERY can explode.

- Keep sparks, flames, and cigarettes away from battery.

To prevent EXPLOSION when:

- **INSTALLING A NEW BATTERY** — disconnect negative cable from old battery first and connect to new battery last.
- **CONNECTING A BATTERY CHARGER** — remove battery from welder by disconnecting negative cable first, then positive cable and battery clamp. When reinstalling, connect negative cable last. Keep well ventilated.

USING A BOOSTER — connect positive lead to battery first then connect negative lead to the negative battery lead at engine foot.

⚠ WARNING

BATTERY ACID can burn eyes and skin.

- Wear gloves and eye protection and be careful when working near battery.
- Follow instructions printed on battery.

IMPORTANT: To prevent ELECTRICAL DAMAGE WHEN:

- Installing new batteries.
- Using a booster.

Use correct polarity — Negative Ground.

EXHAUST OUTLET PIPE

Remove cap from muffler pipe protruding from the roof.

Using the clamp provided secure the outlet pipe to the outlet tube with the pipe positioned such that it will direct the exhaust in the desired direction away from the air intake. Tighten using a wrench (See Figure to the right).

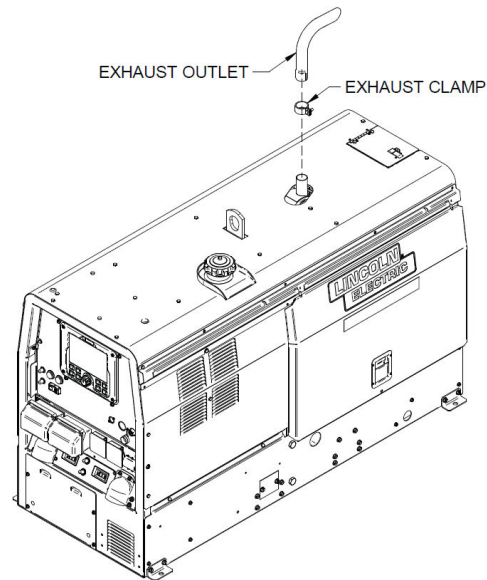

SPARK ARRESTOR

Some federal, state or local laws may require that gasoline or diesel engines be equipped with exhaust spark arrestors when they are operated in certain locations where unarrested sparks may present a fire hazard.

The muffler on the FRONTIER 400X has an internal USFS certified Spark Arrestor.

AIR CLEANER SERVICE INDICATOR

Air cleaner service indicator provides a Go/No-Go visual indication of useful filter service life. The indicator is located inside the service door.

MACHINE GROUNDING

Because this portable engine driven welder creates its own power, it is not necessary to connect its frame to an earth ground, unless the machine is connected to premises wiring (home, shop, etc.).

To prevent dangerous electric shock, other equipment powered by this engine driven welder must:

1. be grounded to the frame of the welder using a grounded type plug, or
2. be double insulated.

When this welder is mounted on a truck or trailer, its frame must be securely connected to the metal frame of the vehicle. When this engine driven welder is connected to premises wiring such as that in a home or shop, its frame must be connected to the system earth ground. See further connection instructions in the section entitled STANDBY POWER CONNECTIONS as well as the article on grounding in the latest National Electrical Code and the local codes.



In general, if the machine is to be grounded, it should be connected with a #8 or larger copper wire to a solid earth ground such as a metal ground stake going into the ground for at least 10ft. (3.1m) or to the metal framework of a building which has been effectively grounded. The National Electric Code lists a number of alternate means of grounding electrical equipment. A machine grounding stud marked with the symbol is provided on the front of the welder.

AUXILIARY POWER RECEPTACLES

Start the engine and set the RUN/STOP/IDLE control switch to the “High Idle” position. Voltage is now correct at the receptacles for auxiliary power. This must be done before a tripped GFCI can be reset properly. See the MAINTENANCE section for more detailed information on testing and resetting the GFCI.

The auxiliary power of the Frontier® 400X consists of two 20 Amp 120 VAC (5-20R) duplex receptacles with GFCI protection, one 50 Amp 120/240 VAC single phase (14-50R) receptacle and one 50 Amp 240 VAC three phase (15-50R) receptacle.

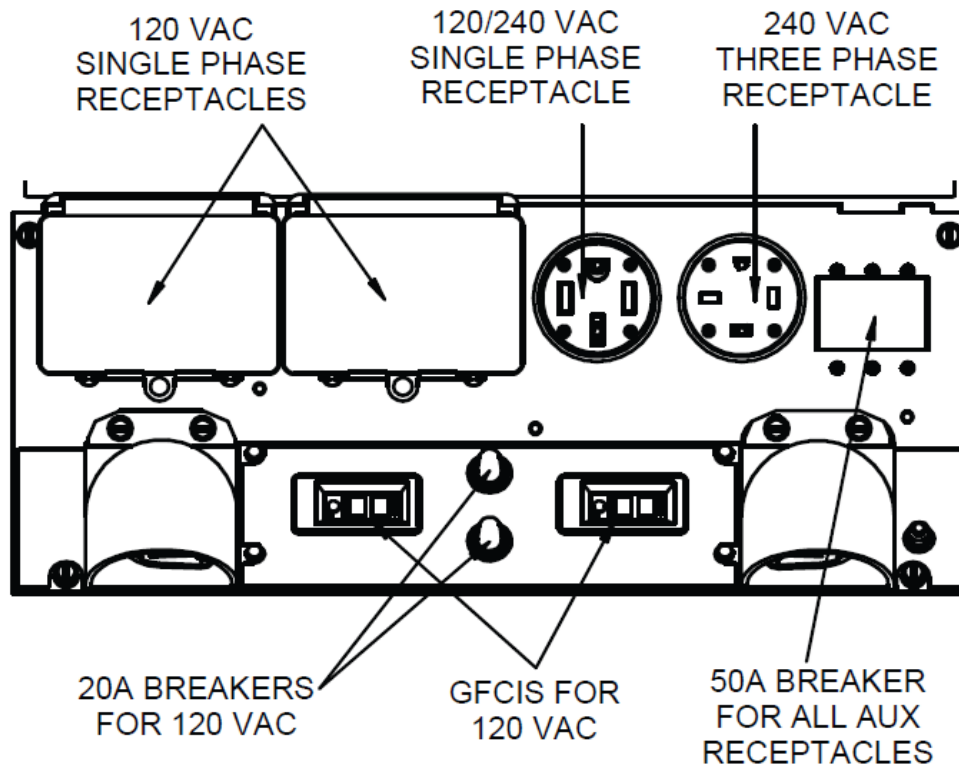

The auxiliary power capacity is 10,000 watts continuous of 60 Hz, single phase power. The auxiliary power capacity rating in watts is equivalent to volt-amperes at unity power factor.

The 240 VAC single phase output can be split to provide two separate 120 VAC outputs with a max permissible current of 50 amps per output to two separate 120 VAC branch circuits. NOTE: These circuits are opposite polarities and cannot be paralleled. Output voltage is within ± 10% at all loads up to rated capacity.

The three phase auxiliary power capacity is 11,000 watts continuous at 60 Hz.

120 VAC DUPLEX RECEPTACLE AND GFCI

A GFCI protects the two 120 VAC auxiliary power receptacles.

A GFCI (Ground Fault Circuit Interrupter) is a device to protect against electric shock should a piece of defective equipment connected to it develop a ground fault. If this situation should occur, the GFCI will trip, removing voltage from the output of the receptacle. If a GFCI is tripped see the MAINTENANCE section for detailed information on testing and resetting it. A GFCI should be properly tested before each use.

The 120 VAC auxiliary power receptacles should only be used with three wire grounded type plugs or approved double insulated tools with two wire plugs. The current rating of any plug used with the system must be at least equal to the current capacity of the associated receptacle.

CIRCUIT BREAKERS

All auxiliary power is protected by circuit breakers. The 120 VAC duplex receptacles have 20 amp circuit breakers for each receptacle. The 120/240V single phase and the 240V three phase receptacles have a 50 amp 3-pole circuit breaker that disconnects both hot leads and all three phases simultaneously.

ELECTRICAL DEVICE USE

This machine has been designed to support the power requirements of common jobsite tools and equipment. However, due to the nature of auxiliary power output, it is recommended for the operator to review the sensitivity and protections of any tools or equipment used with this machine to prevent any damage or failures.

WELDING OUTPUT CABLES

With the engine off, connect to the terminals provided. These connections should be checked periodically and tightened if necessary.

Listed in Table below are copper cable sizes recommended for the rated current and duty cycle. Lengths stipulated are the distance from the welder to work and back to the welder again. Cable sizes are increased for greater lengths primarily for the purpose of minimizing cable voltage drop.

OUTPUT CABLE GUIDELINES						
AMPERES	PERCENT DUTY CYCLE	CABLE SIZES FOR COMBINED LENGTHS OF ELECTRODE AND WORK CABLES [RUBBER COVERED COPPER - RATED 167°F (75°C)]**				
		0 to 50 Ft.	50 to 100 Ft.	100 to 150 Ft.	150 to 200 Ft.	200 to 250 Ft.
200	60	2	2	2	1	1/0
200	100	2	2	2	1	1/0
250	30	3	3	2	1	1/0
250	40	2	2	1	1	1/0
250	60	1	1	1	1	1/0
250	100	1	1	1	1	1/0
300	60	1	1	1	1/0	2/0
300	100	2/0	2/0	2/0	2/0	3/0
350	40	1/0	1/0	2/0	2/0	3/0
400	60	2/0	2/0	2/0	3/0	4/0
400	100	3/0	3/0	3/0	3/0	4/0



OUTPUT CABLE GUIDELINES						
AMPERES	PERCENT DUTY CYCLE	CABLE SIZES FOR COMBINED LENGTHS OF ELECTRODE AND WORK CABLES [RUBBER COVERED COPPER - RATED 167°F (75°C)]**				
		0 to 50 Ft.	50 to 100 Ft.	100 to 150 Ft.	150 to 200 Ft.	200 to 250 Ft.
500	60	2/0	2/0	3/0	3/0	4/0
500	100	3/0	3/0	4/0	2-2/0	3-3/0

Note: ** Tabled values are for operation at ambient temperatures of 104°F (40°C) and below. Applications above 104°F (40°C) may require cables larger than recommended, or cables rated higher than 167°F (75°C).

CABLE INSTALLATION

Install the welding cables to your FRONTIER 400X as follows.

1. The engine must be OFF to install welding cables.
2. Remove the flanged nuts from the output terminals
3. Connect the electrode holder and work cables to the weld output terminals. The terminals are identified on the case front.
4. Tighten the flanged nuts securely
5. Be certain that the metal piece you are welding (the “work”) is properly connected to the work clamp and cable.
6. Check and tighten the connections periodically.

 CAUTION	
	<p>Loose connections will cause the output terminals to overheat. The terminals may eventually melt.</p> <p>Do not cross the welding cables at the output terminal connection. Keep the cables isolated and separate from one another.</p>

CABLE INDUCTANCE AND ITS EFFECT ON WELDING

Excessive cable inductance will cause the welding performance to degrade. There are several factors that contribute to the overall inductance of the cabling system including cable size, number of loops and total loop area. The loop area is defined by the separation distance between the electrode and work cables and the overall welding loop length. Welding loop length = electrode cable (A) + work cable (B) + work path (C) (See below).

INSTALLATION

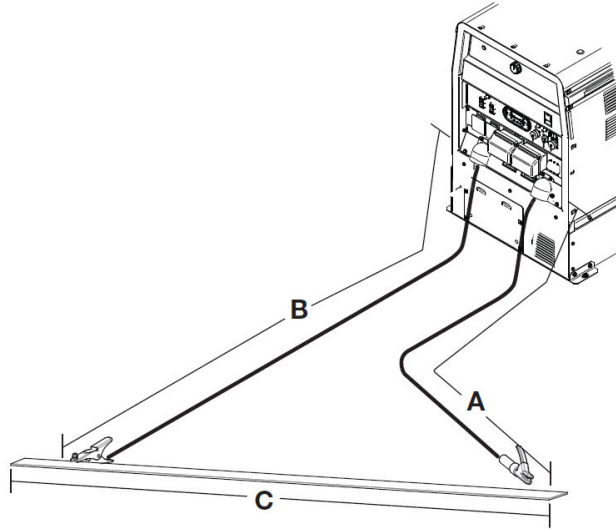

To minimize inductance always use the appropriate size cables, and whenever possible, run the electrode and work cables in close proximity to one another to minimize the loop area. Since the most significant factor in cable inductance is the welding loop length, avoid excessive lengths and do not coil excess cable. Excess cable should be placed in a straight or zigzag pattern between the machine and work (see below).

Incorrect Welding Loop

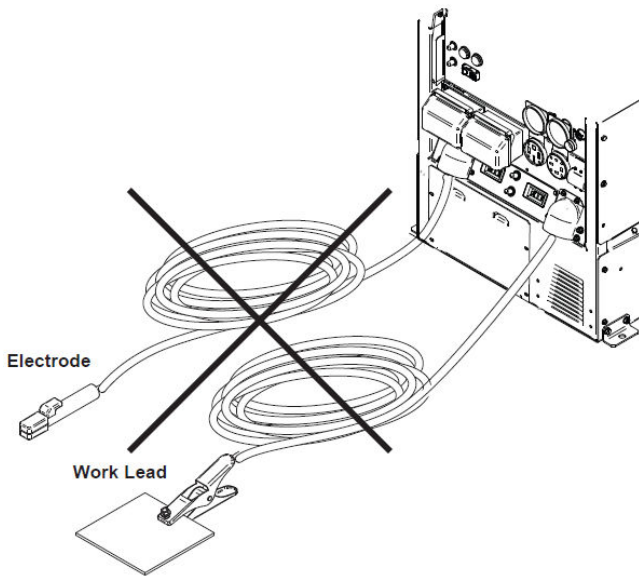

Correct Welding Loop

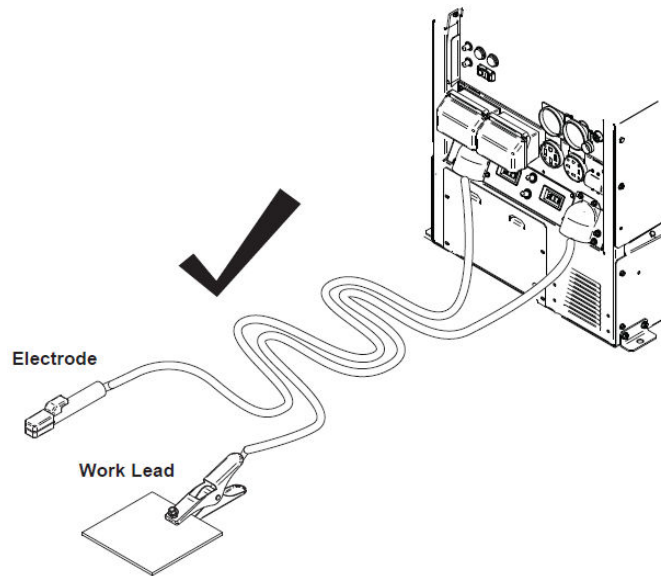

If a spooling mechanism is used to store the welding cables, unspool the cables. Avoid leaving more than 30 feet of cable on each storage spool, and for best performance, completely unspool the welding cables.

For long work piece lengths, a sliding ground should be considered to keep the total welding loop length as short as possible.

CROSSLINK TECHNOLOGY

This machine features CrossLinc technology, which allows for remote control of the welding output via the weld cables rather than a control cable. As result, the control cable is no longer needed when connected to a CrossLinc compatible wire feeder or remote control.

This machine will function with all CrossLinc compatible wire feeders except for the oldest LN-25X models. Incompatible models include:

Code # 12432

Code # 12504

REMOTE CONTROL CONNECTIONS

The FRONTIER 400X is equipped with a 12-pin remote connector for attaching remote control accessories.

NOTE: To connect accessories with a 6-pin connector, use the 6-pin to 12-pin adapter (K2909-1).

REMOTE OUTPUT CONTROL

To enable remote control capabilities, turn on remote control with the button on the user interface. When remote control is enabled, output is controlled through the 12-pin connector and the output control knob on the Frontier will be disabled.

When a CrossLinc device is connected, the remote output control is disabled, and the CrossLinc device is in control of the output.

REMOTE WELD TERMINALS

By default, the weld terminals are ON when a weld mode is selected. To use a remote output control switch or a foot pedal, the weld terminals can be changed to REMOTE in the weld settings within the desired weld mode.

ACCESSORY CONNECTION DIAGRAMS

 WARNING	
	Shut off welder before making or removing any electrical connections.

When connecting an accessory to the Frontier® 400X, the following steps should be taken:

- Shut off the welder.
- Connect your leads for the desired accessory. For electrode positive, connect the electrode cable to the "+" terminal of the welder and work cable to the "-" terminal of the welder.

For electrode negative, connect the electrode cable "-" terminal of the welder and work cable to the "+" terminal of the welder. Installation diagrams for common setups are WARNING included on the following pages.

CROSSLINC WIRE FEEDER SETUP EXAMPLE

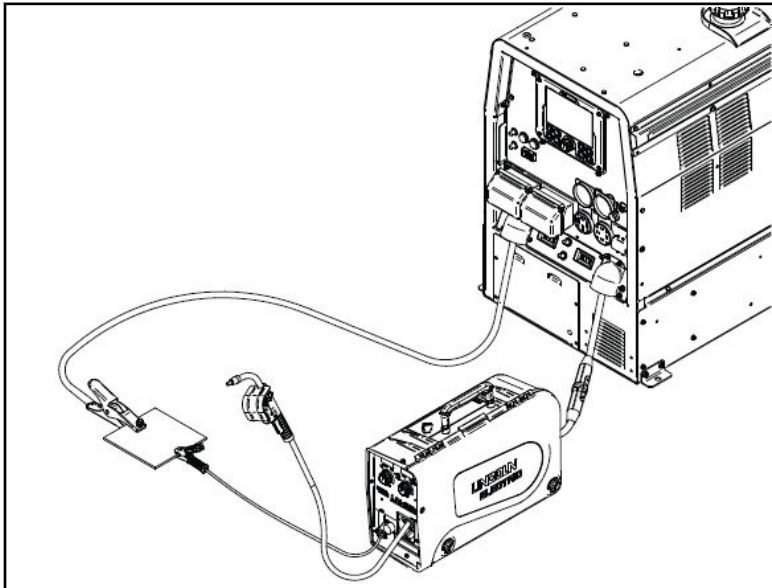

Description	Product Number	QTY
Frontier® 400X Welder/Generator	K3484-1	1
LN-25X Wire Feeder	K4267-2	1
K126® PRO Innershield® 350A FCAW-S Welding Gun	K126-12	1
Electrode Cable - 2/0, 50 ft. (15.3 m), Black	K2485-2	2
Electrode Cable - 2/0, 10 ft. (3.1 m), Black	K2483-2	1
Work Clamp	K910-1	1
Cable Connectors - TWECO to Lug Adaptor	K2487-1	2

CROSSLINC REMOTE SETUP EXAMPLE

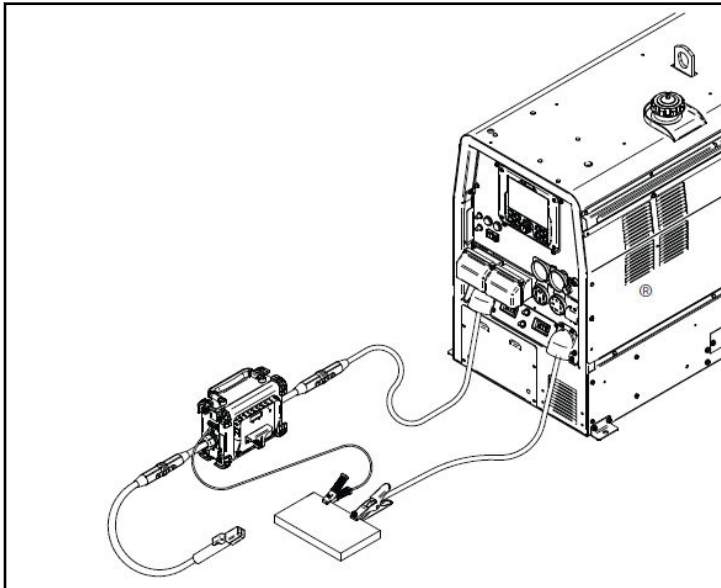

Description	Product Number	QTY
Frontier® 400X Welder/Generator	K3484-1	1
CrossLinc Remote	K4345-1	1
EH-305D Electrode Holder	K909-7	1
Electrode Cable - 2/0, 50 ft. (15.3 m), Black	K2485-2	2
Electrode Cable - 2/0, 10 ft. (3.1 m), Black	K2483-2	1
Work Clamp	K910-1	1
Cable Connectors - TWECO to Lug Adaptor	K2487-1	2

DUAL ARC SETUP EXAMPLE

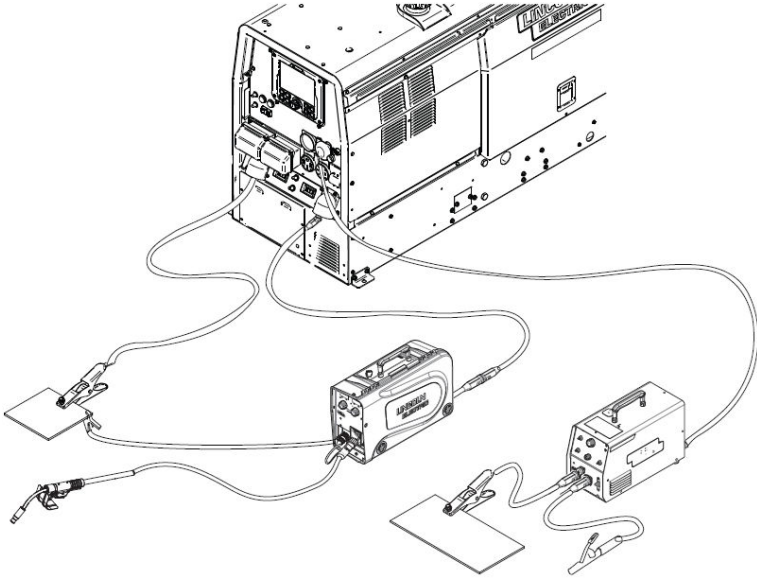
	Description	Product Number	QTY
	Frontier® 400X Welder/Generator	K3484-1	1
	LN-25X Wire Feeder	K4267-2	1
	K126® PRO Innershield® 350A FCAW-S Welding Gun	K126-12	1
	Gas Regulator and Hose Kit	K586-1	1
	Electrode Cable - 2/0, 50 ft. (15.3 m), Black	K2485-2	2
	Electrode Cable - 2/0, 10 ft. (3.1 m), Black	K2483-2	2
	Work Clamp	K910-1	2
	Cable Connectors - TWECO to Lug Adaptor	K2487-1	2
	Invertec® V276	K4868-1	1
	EH-305D Electrode Holder	K909-7	1

TIG SETUP WITH FOOT PEDAL EXAMPLE

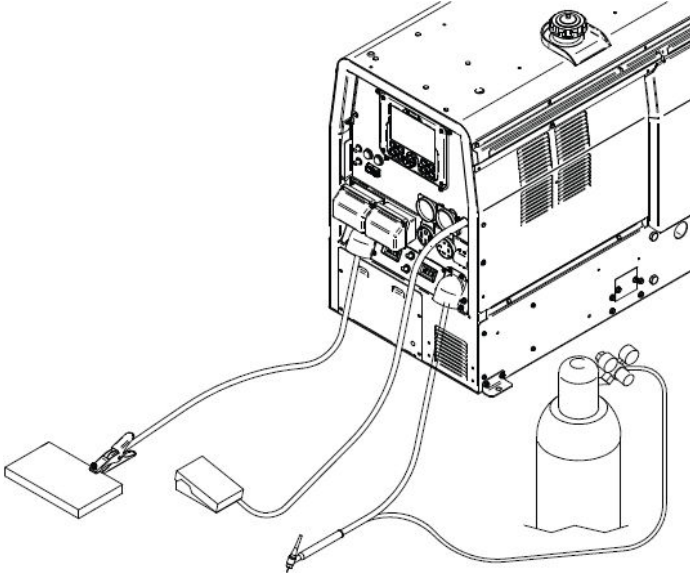
	Description	Product Number	QTY
	Frontier® 400X Welder/Generator	K3484-1	1
	PTA-26V TIG Torch - 25 ft. (7.6 m)	K1783-9	1
	Foot Pedal	K870-2	1
	Gas Regulator and Hose Kit	K586-1	1
	Electrode Cable - 2/0, 50 ft. (15.3 m), Black	K2485-2	2
	Electrode Cable - 2/0, 10 ft. (3.1 m), Black	K2483-2	1
	Work Clamp	K910-1	1
	Cable Connectors - TWECO to Lug Adaptor	K2487-1	2

INSTALLATION

OPERATION

ADDITIONAL SAFETY PRECAUTIONS

Read and understand this entire section before operating your Frontier® 400X.

Do not attempt to use this equipment until you have thoroughly read the engine manufacturer's manual supplied with your welder. It includes important safety precautions, detailed engine starting, operating and maintenance instructions, and parts lists.

WARNING



ELECTRIC SHOCK can kill.

- Do not touch electrically live parts or electrode with skin or wet clothing.
- Insulate yourself from work and ground
- Always wear dry insulating gloves.

WARNING



ENGINE EXHAUST can kill.

- Use in open, well ventilated areas or vent exhaust outside
- Do not stack anything near the engine.

WARNING



MOVING PARTS can injure.

- Do not operate with doors open or guards off.
- Stop engine before servicing.
- Keep away from moving parts.

The serviceability of a product or structure utilizing the welding modes is and must be the sole responsibility of the builder/user. Many variables beyond the control of The Lincoln Electric Company affect the results obtained in applying these programs. These variables include, but are not limited to, welding procedure, plate chemistry and temperature, weldment design, fabrication methods and service requirements. The available range of a welding mode may not be suitable for all applications, and the builder/user is and must be solely responsible for welding mode selection.

RECOMMENDED APPLICATIONS

WELDER - The FRONTIER 400X provides excellent constant current DC welding output for stick (SMAW) and TIG (GTAW) welding, as well as excellent constant voltage DC welding output for MIG (GMAW), Innershield (FCAW), Outershield (FCAW - G), and Metal Core (GMAW - C) welding. In addition the Frontier 400X can be used for Arc Gouging with carbons up to 5/16 inch (8.0 mm) in diameter.

GENERATOR -The FRONTIER 400X provides smooth 120 / 240 VAC single phase and 240 VAC three phase output for auxiliary power and emergency standby power.

The Frontier 400X is **NOT RECOMMENDED** for pipe thawing.

WARNING



Pipe Thawing with an arc welder can cause fire, explosion, damage to electrical wiring or to the arc welder if done improperly.

The use of an arc welder for pipe thawing is not approved by the CSA, nor is it recommended or supported by Lincoln Electric.

ADDING FUEL

WARNING



DIESEL FUEL can cause fire.

- Stop engine while fueling.
- Do not smoke when fueling.
- Keep sparks and flame away from tank.
- Do not leave unattended while fueling.
- Wipe up spilled fuel and allow fumes to clear before starting engine.
- Do not overfill tank, fuel expansion may cause overflow. USE ULTRA-LOW SULFUR DIESEL FUEL ONLY
- Remove the fuel tank cap.
- Fill the tank. DO NOT FILL THE TANK TO THE POINT OF OVERFLOW.
- Replace the fuel cap and tighten securely.
- See Engine Owner's manual for specific fuel recommendations.

BREAK-IN PERIOD

The engine will use a small amount of oil during its "break-in" period. The break-in period is about 50 running hours. Change the oil after the first 50 hours of operation. Thereafter, follow the engine service and maintenance schedule located in the Engine Operator's Manual.

CAUTION



During break-in, subject the engine driven welder to moderate loads. Avoid long periods running at idle. Before stopping the engine, remove all loads and allow the engine to cool several minutes.

ENGINE OPERATION

Before starting engine:

- Be sure the machine is on a level surface.
- Open side engine door and remove the engine oil dipstick and wipe it with a clean cloth. Reinsert the dipstick and check the level on the dipstick.
- Add oil (if necessary) to bring the level up to the full mark. Do not overfill. Close engine door.
- Check radiator for proper coolant level. (Fill if necessary).
- See Engine Owner's Manual for specific oil and coolant recommendations.

STARTING THE ENGINE

1. Remove all plugs connected to the AC power receptacles.
2. Set RUN / STOP / IDLE switch to AUTO IDLE / RUN position.
3. Press the GLOW PLUG button to preheat the engine before starting if needed. Then, press and hold the START button until the machine turns over.
4. Release the engine START button immediately when the engine starts.
5. The engine will run at high idle speed for approximately 12 seconds and then drop to low idle speed. Allow the engine to warm up at low idle for several minutes before applying a load and/or switching to high idle.

Note: Allow a longer warm up time in cold weather.

CAUTION



- Do not allow the starter motor to run continuously for more than 20 seconds.
- Do not push the START button while the engine is running because this can damage the ring gear and/or the starter motor.

STOPPING THE ENGINE

Remove all welding and auxiliary power loads and allow the engine to run at low idle speed for a few minutes to cool the engine.

Turn off the engine by placing the RUN / STOP / IDLE switch in the STOP position.

Note: A fuel shut off valve is located on the fuel pre-filter.

TYPICAL FUEL CONSUMPTION

Refer to the table below for typical fuel consumption of the Frontier 400X engine for various operating scenarios.

Perkins 403F-15T Fuel Consumption			
	GAL. / HR.	L / HR.	RUN TIME (HRS.) WITH FULL TANK*
High Idle, no load	0.56	2.11	35.84
Low Idle, no load	0.34	1.28	59.14
Welding - 100A @ 24V	0.68	2.56	29.57
Welding - 200A @ 28V	1.18	4.48	16.90
Welding - 300A @ 32V	1.23	4.64	16.32
Welding - 325A @ 33V	1.31	4.96	15.26
Welding - 400A @ 26V	1.33	5.02	15.07
Auxiliary - 10kW Single Phase Power	1.12	4.26	17.79
Auxiliary - 11kW Three Phase Power	1.21	4.58	16.54

*Full Tank equals 20 gal. (75.7L)

Kubota D1503-M Fuel Consumption			
	GAL. / HR.	L / HR.	RUN TIME (HRS.) WITH FULL TANK*
High Idle, no load	0.43	1.63	46.39
Low Idle, no load	0.29	1.09	69.58
Welding - 100A @ 24V	0.58	2.21	34.29
Welding - 200A @ 28V	0.80	3.01	25.17
Welding - 300A @ 32V	1.12	4.26	17.79
Welding - 325A @ 33V	1.27	4.80	15.77
Welding - 400A @ 26V	1.25	4.74	15.98
Auxiliary - 10kW Single Phase Power	1.19	4.51	16.78
Auxiliary - 11kW Three Phase Power	1.28	4.86	15.56

*Full Tank equals 20 gal. (75.7L)

SYSTEM CONTROLS

All welder and engine controls are located on the case front panel.

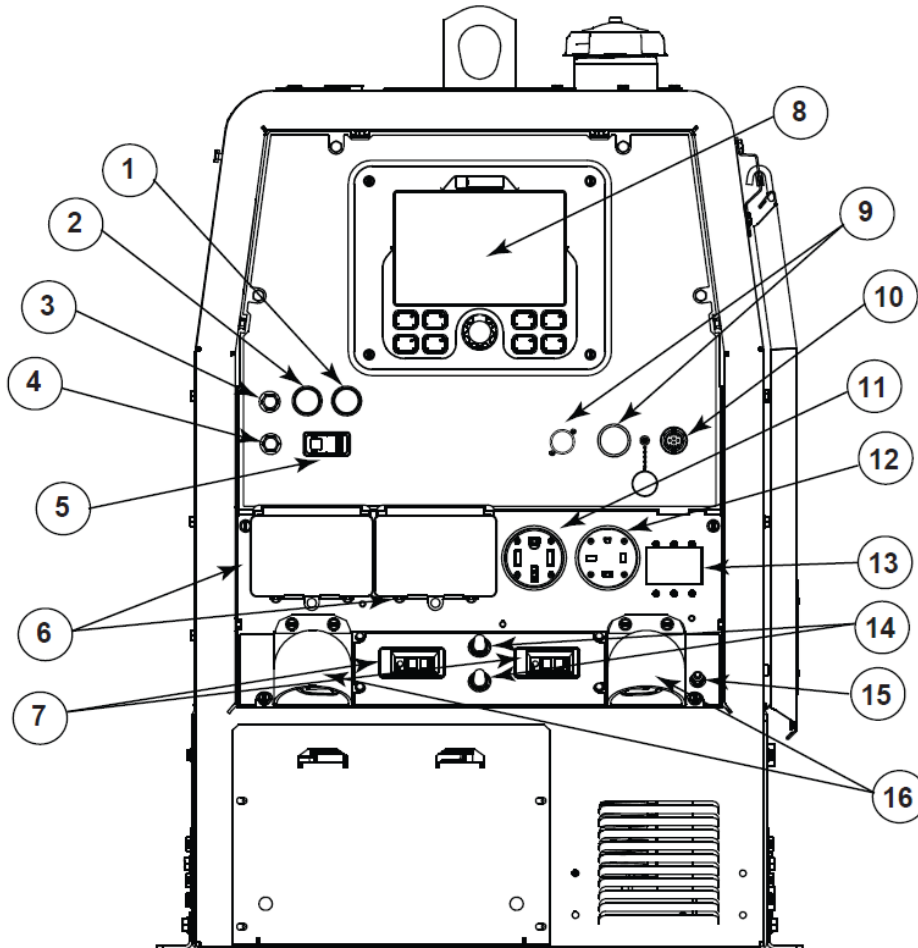

1. START PUSH BUTTON - Energizes the starter motor to crank the engine.
2. GLOW PLUG PUSH BUTTON - Activates the glow plugs when pushed. Hold for approximately 10 seconds prior to engine starting in cold weather. Glow plug should not be activated for more than 20 seconds continuously.
3. 10A BREAKER FOR 40V APEX® SYSTEM
4. 10A BREAKER FOR 12V ENGINE BATTERY
5. RUN / STOP / IDLE SWITCH - The switch has three positions. The right position is OFF, the middle position is AUTO IDLE / RUN, and the left position is HIGH IDLE / RUN.
 - a. In the OFF position, the engine will turn off.
 - b. In the HIGH IDLE position, the engine runs at the high idle speed controlled by the governor.
 - c. In the AUTO IDLE position, the idler operates as follows:
 - When switched from HIGH to AUTO or after starting the engine, the engine will operate at full speed for approximately 12 seconds and then go to low idle speed.
 - When the electrode touches the work or power is drawn for lights or tools (approximately 100 watts minimum) the engine accelerates and operates at full speed.

OPERATION

- When welding ceases and the auxiliary power load is turned off, a fixed time delay of approximately 12 seconds starts.
 - If the welding or auxiliary power load is not restarted before the end of the time delay, the idler reduces the engine speed to low idle speed.
 - The engine will automatically return to high idle speed when the welding load or auxiliary power load is reapplied.
- 6.** 120 VAC SINGLE PHASE RECEPTACLES - NEMA 5-20R receptacles that provides 120 VAC single-phase auxiliary power. Each receptacle has a 20 amp rating.
 - 7.** GFCI MODULES - Protects the 120 VAC duplex receptacles.
 - 8.** GRAPHICAL USER INTERFACE - Controls and displays information about the machine. See section USER INTERFACE CONTROLS for operation information.
 - 9.** APEX® SYSTEM CONNECTORS - Optional connectors available via separate kit. Kit includes needed components to power an APEX® System.
 - 10.** 12-PIN CONNECTOR - Used for attaching optional remote control equipment. The K2909-1 (12-pin to 6-pin) adapter can be used for attaching to accessories requiring the 6-pin connector.
 - 11.** 120/240 VAC SINGLE PHASE RECEPTACLE - A NEMA 14-50R receptacle that provides 240 VAC or can be split for 120 VAC single-phase auxiliary power. This receptacle has a 50 amp rating. Refer to the AUXILIARY POWER RECEPTACLES section in the INSTALLATION chapter for further information about this receptacle.
 - 12.** 240 VAC THREE PHASE RECEPTACLE - A NEMA 15-50R receptacle that provides 240 VAC three phase auxiliary power. This receptacle has a 50 amp rating.
 - 13.** 50A BREAKER FOR 120V/240V AND 240V RECEPTACLES.
 - 14.** 20A BREAKER FOR 120V RECEPTACLE.
 - 15.** GROUND STUD - Provides a connection point for connecting the machine case to earth ground. Refer to MACHINE GROUNDING in the INSTALLATION section for proper machine grounding information.
 - 16.** WELD TERMINALS - These 1/2" - 13 studs with flanged nuts provide welding connection points for the electrode and work cables. For positive polarity welding the electrode cable connects to the "+" positive terminal and the work cable connects to this "-" negative terminal. For negative polarity welding the work cable connects to the "+" positive terminal and the electrode cable connects to this "-" negative.

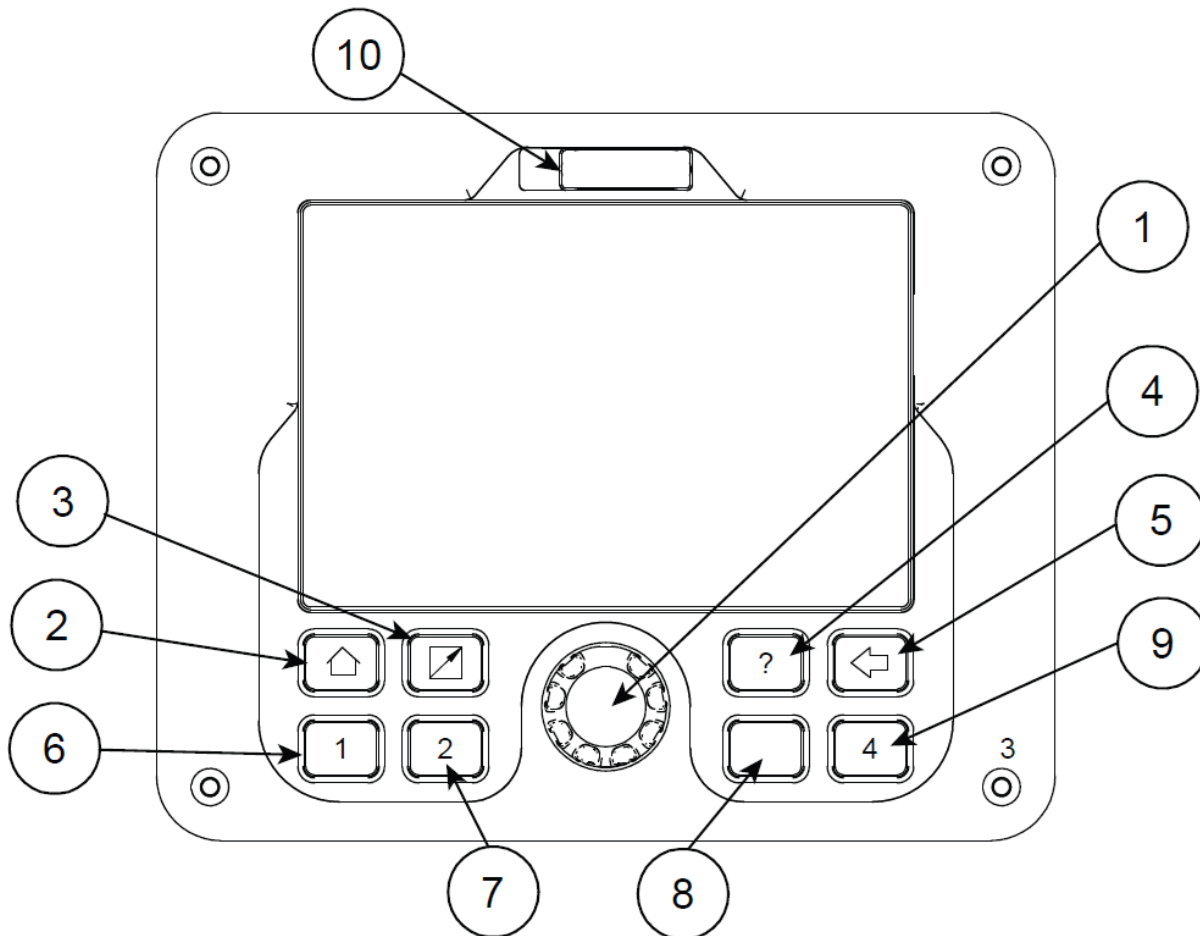
USER INTERFACE CONTROLS

1. **KNOB AND PUSH BUTTON** - Rotate the knob to adjust values and move through the menus and push the knob to select values.
2. **HOME BUTTON** - Will return you to the home screen from any menu.
3. **REMOTE BUTTON** - Enable/Disable Remote Control.
4. **HELP / READY.SET.WELD®** - Press to get more information about a highlighted feature or setting. After selecting a welding process, press to enter READY.SET. WELD®.
 READY.SET.WELD® is a guided setup feature that provides a recommended output range based off a given material, material thickness, electrode type, and electrode diameter.
5. **BACK** - Return to the previous screen.
6. **MEMORY 1** - Recall saved Memory 1 process and settings or press and hold to store new memory.
7. **MEMORY 2** - Recall saved Memory 2 process and settings or press and hold to store new memory.
8. **MEMORY 3** - Recall saved Memory 3 process and settings or press and hold to store new memory.
9. **MEMORY 4** - Recall saved Memory 4 process and settings or press and hold to store new memory.
10. **USB PORT** - Conduct machine updates by inserting a USB drive.

HOME SCREEN

Use the knob to navigate between the following processes; press the knob to select desired welding modes as shown below.

The machine comes with the available welding modes:

1. Stick (SMAW)
2. Flux-cored self-shielded wire (FCAW-S)
3. Flux-cored Gas-shielded (FCAW-G)
4. MIG (GMAW)
5. Gouging (CAC-A)
6. TIG (GTAW)
7. Pipe (SMAW)**

**Only available on Frontier 400X Pipe model.

Selecting a weld mode determines the output characteristics of the Frontier® 400X power source. The proper weld mode should be used based off desired application. Many variables beyond the control of The Lincoln Electric Company affect the results obtained in applying these programs. These variables include, but are not limited to, welding procedure, plate chemistry and temperature, weldment design, fabrication methods and service requirements.

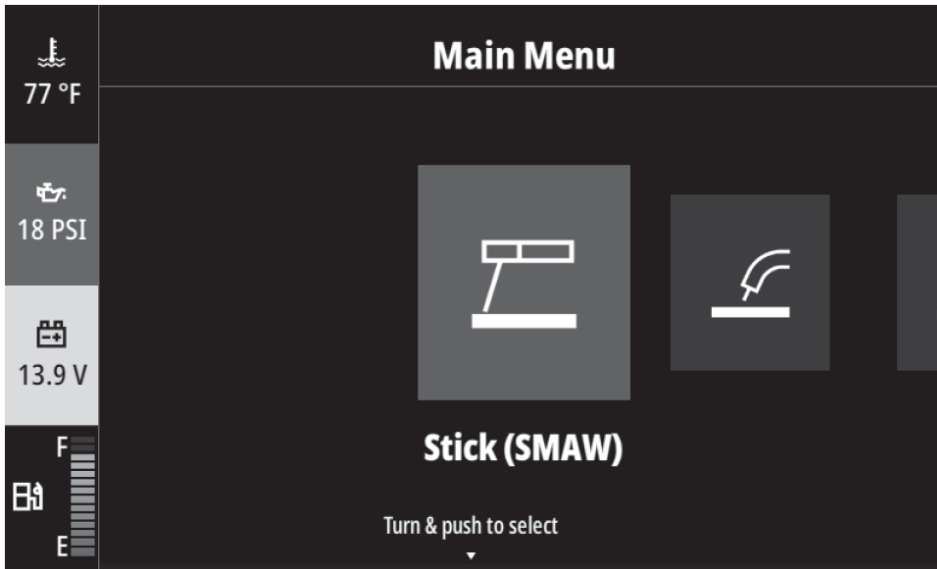

WELD MODE SCREEN WELD SETTINGS

After selecting the weld process, use the center knob to adjust the welding output (see figure below)

In constant current modes, the knob adjusts the welding amperage; while in constant voltage modes, the knob adjusts the welding voltage.

Next to the engine indicators are weld setting and operation indicators.

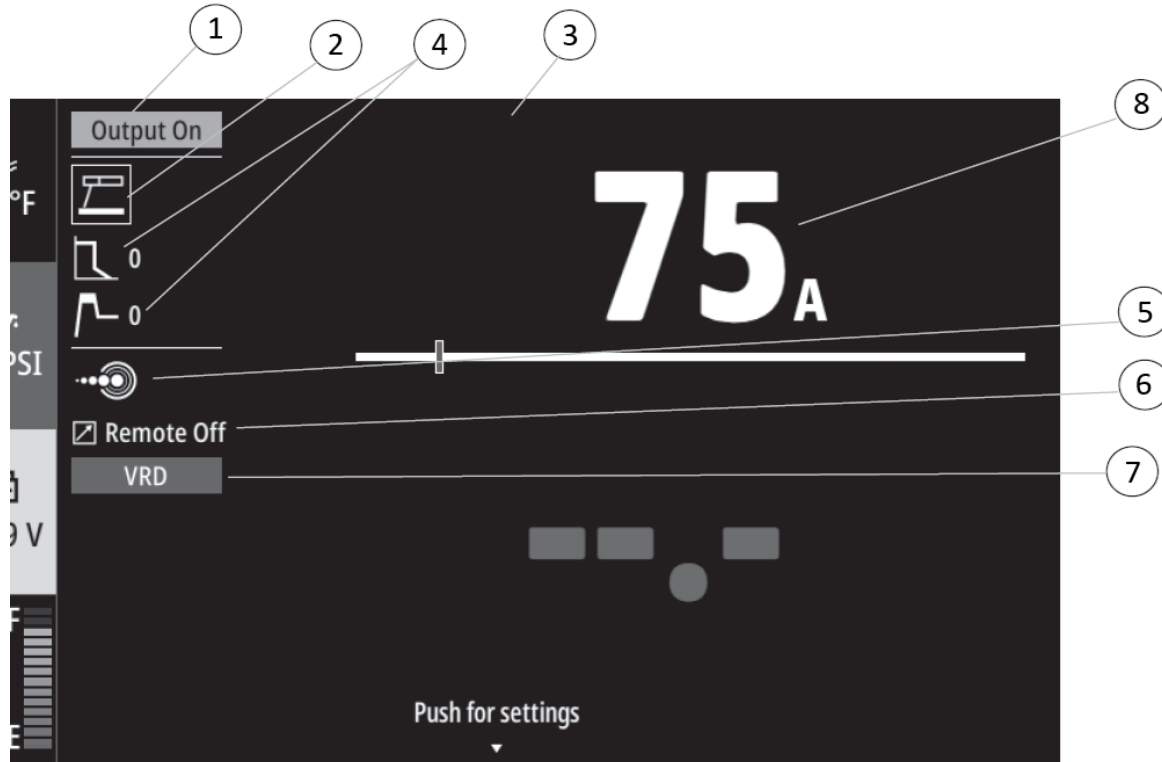

1. OUTPUT STATUS - Identifies if the welding studs are ON or OFF.
2. WELDING MODE - Indicates the current welding mode of the machine.
3. STANDBY TIMER - When Auto Stop/Start is enabled, a countdown timer will appear on the top of the screen (Timer display not shown in figure above).
4. WELD MODE SETTING - Specifies the weld mode setting such as Arc Force and Hot Start. Press the knob to access the mode settings. See the WELD MODE SETTINGS section for more details.
5. CROSSLINC INDICATOR - Shows the machine is actively communicating with a CrossLinc accessory.
6. REMOTE STATUS - Indicates if a remote output control is ON or OFF.
7. VRD INDICATOR - When VRD is active, a red indicator will appear on the UI if the OCV (Open Circuit Voltage) is equal to or greater than 30V and a green light will appear if the OCV is less than 30V. NOTE: These indicators do not appear during welding (See the VRD section in the installation section of this book)
8. WORK POINT - Indicates the output where the machine has been set.

WELD MODE SCREEN ENGINE INDICATORS

On the left hand side of the screen, the operator can see status indicators of the machine.

INDICATOR	OPERATION	
1 - ENGINE TEMPERATURE	Displays the engine coolant temperature.	
2 - OIL PRESSURE	Displays the engine oil pressure when the engine is running.	
3 - BATTERY VOLTAGE	Displays the battery voltage and indicates that the charging system is functioning properly.	
4 - FUEL LEVEL	Displays the level of diesel fuel in the fuel tank.	

If the machine status moves outside of the recommended operating ranges, the icons will change color:

- Black - Normal operation
- Yellow - Warning
- Red - Critical

A warning message will appear. The operator will need to click to acknowledge it.

ACTIVE WELD SCREEN

After striking welding arc, the screen will change to the ACTIVE WELD SCREEN to show the real time amperage and amperage and voltage for approximately 5 seconds, and the UI will automatically return to the weld mode screen. This allows the operator to read the actual current and voltage just prior to when welding was ceased.

The accuracy of the meters is +/- 3%.

When CrossLinc® wire feeder with True Voltage Technology (TVT) is connected, the screen will display the actual machine output. This will vary from the preset voltage on the wire feeder because TVT compensates for the voltage drop in the welding loop.



WELD MODE SETTINGS

Within an active welding process, press the knob to view additional arc options.

Each mode offers several options to fine tune the arc welding performance. The options available will depend on the weld mode selected. Welding settings are remembered between each weld mode.

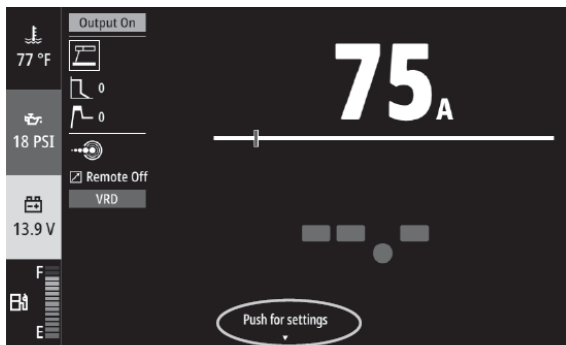

Push knob to access the Weld Settings screen

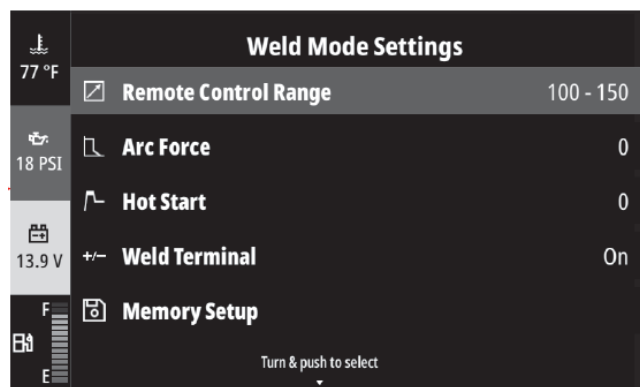

WELD MODE SETTINGS REMOTE

Remote Control Range - Allows the user to refine the output range that can be controlled remotely.

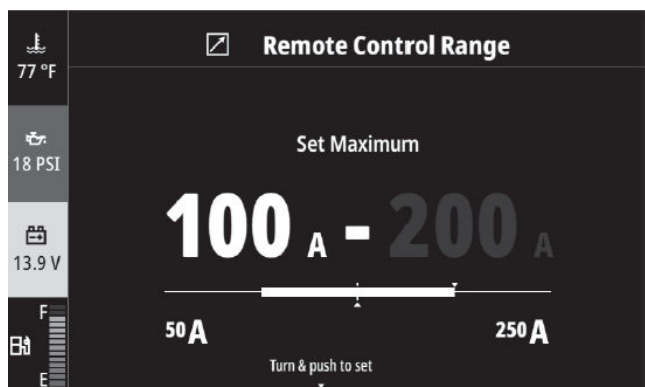
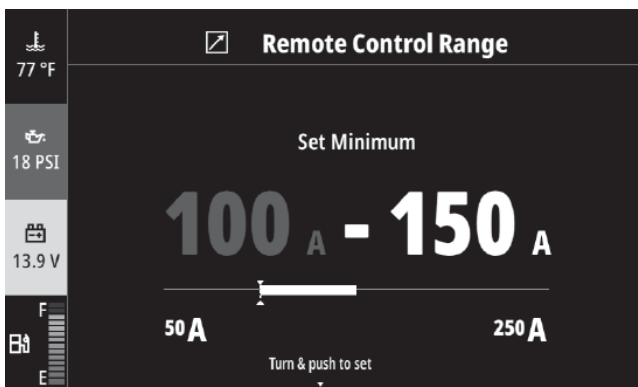

WELD MODE SETTINGS HOT START

Hot Start -

Provides a temporary increase of the output current during the start of a weld. This helps ignite the arc quickly and reliably, preventing the electrode from sticking. The setting can be adjusted from 0 (Off) to +10. The higher the value the greater the output current during arc strike.

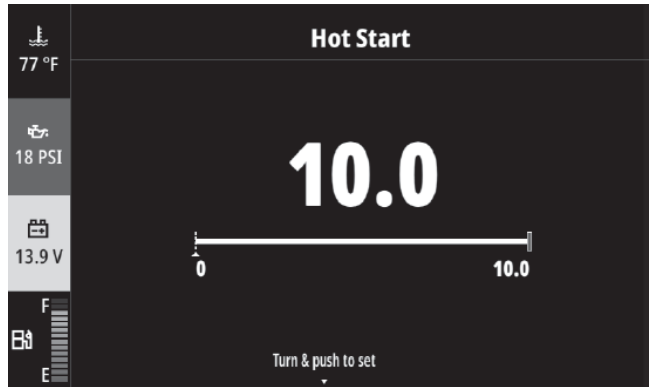
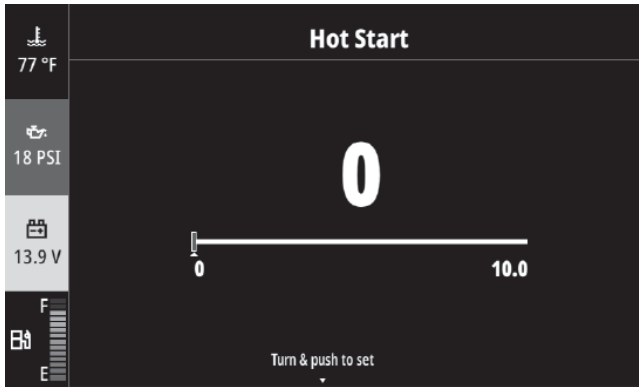

WELD MODE SETTINGS ARC FORCE

Arc Force -Used to prevent the electrode from sticking during welding. It provides a temporary increase in current when the arc length becomes very short. Increasing the value from -10 (Soft) to +10 (Crisp) increases the short circuit current and prevents sticking of the electrode to the plate while welding, while decreasing the value reduces the amount of spatter.



Pinch -Changes the rate of current rise will change when the electrode short circuits to the work. Increasing the pinch from -10 to +10 may reduce spatter, while decreasing the pinch will make the puddle more fluid, resulting in a flatter and smoother weld bead.

WELD MODE SETTING WELD TERMINALS

Weld Terminal -Allows the operator to select if the welding terminals are always electrically hot or turned on or off via a remote trigger.

WELD MODE SETTINGS MEMORY

Memory Mode -Allows the operator save a memory based off the current weld mode and welding settings or recall a previously saved memory.

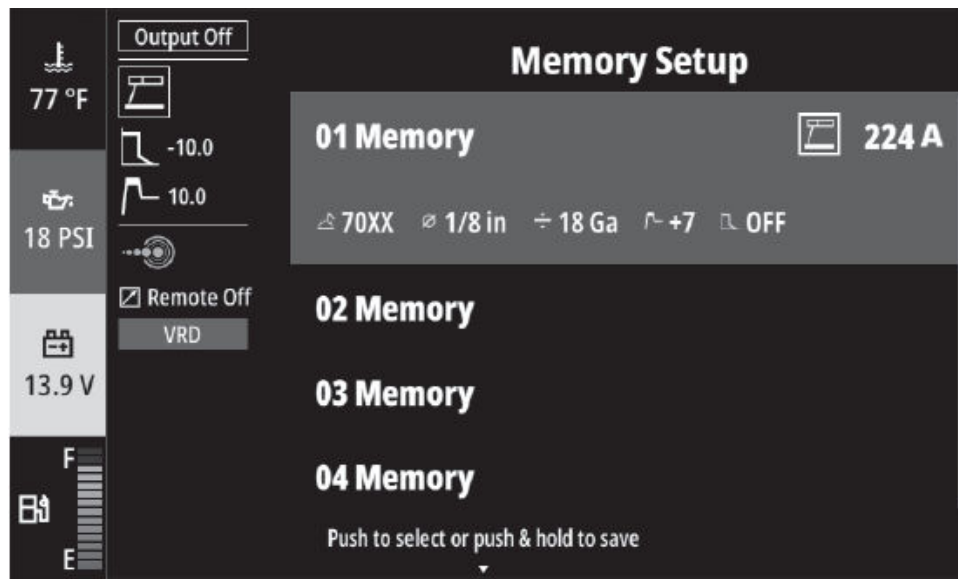

Frequency -Adjusting the frequency from "OFF" to a value between 0.1-20 Hz will turn on pulse TIG. The frequency changes the number of pulses per second. Pulse TIG can help to minimize burn through on thin materials by reducing the heat input.

Percent Peak Current -If pulse frequency is ON, this setting changes percentage of time spent at the peak current vs the background current. The operator can set the value from 5% up to 95%, which affects the amount of heat input into the weld. The default setting is 50%.

Remote Accessory Type -Allows the operator to change between a Foot Pedal or Hand Control.

Start Type -Choose between Touch Start and Scratch Start. Touch Start is a cleaner process needing only a light, quick touch of the tungsten to the work piece. Scratch start requires dragging the tungsten across the work much like striking a match. Scratch start can be easier to use but could potentially contaminate the weld and the tungsten.

NOTE: Touch Start mode avoids tungsten contamination without the use of a high frequency unit. During the time the tungsten is touching the work, there is very little voltage or current and, in general, this avoids tungsten contamination. Then, the tungsten is gently lifted off the work in a rocking motion, which establishes the arc. To stop the arc, simply lift the TIG torch away from the work piece. When the arc voltage reaches approximately 30 volts, the arc will go out and the machine will automatically reset to the touch start current level. The tungsten may then be retouched to the work piece to restrike the arc. The arc may also be started and stopped with an amptrol or arc start switch.

OPERATION

While using TOUCH START TIG mode, it is important to use the proper welding cable size to ensure expected performance levels.

ENGINE STATUS SCREEN

The Engine Status Screen provides information about the engine servicing and operation. In the MAIN MENU, use the knob to scroll and press to select the ENGINE SCREEN (See picture below).

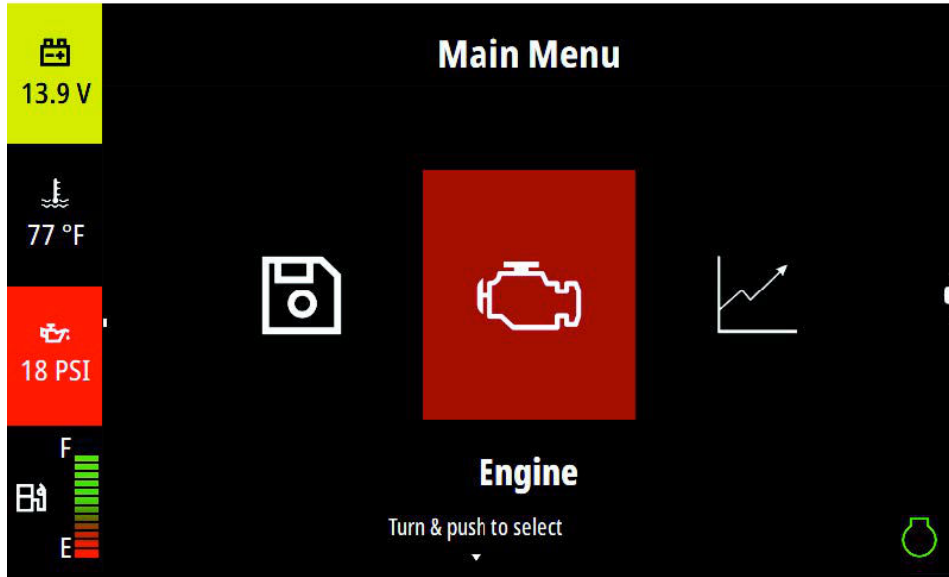

Within the screen, six engine parts are monitored for service:

- OIL
- AIR FILTER
- WATER SEPARATOR
- FUEL FILTER
- ENGINE COOLANT
- ALTERNATOR BELT

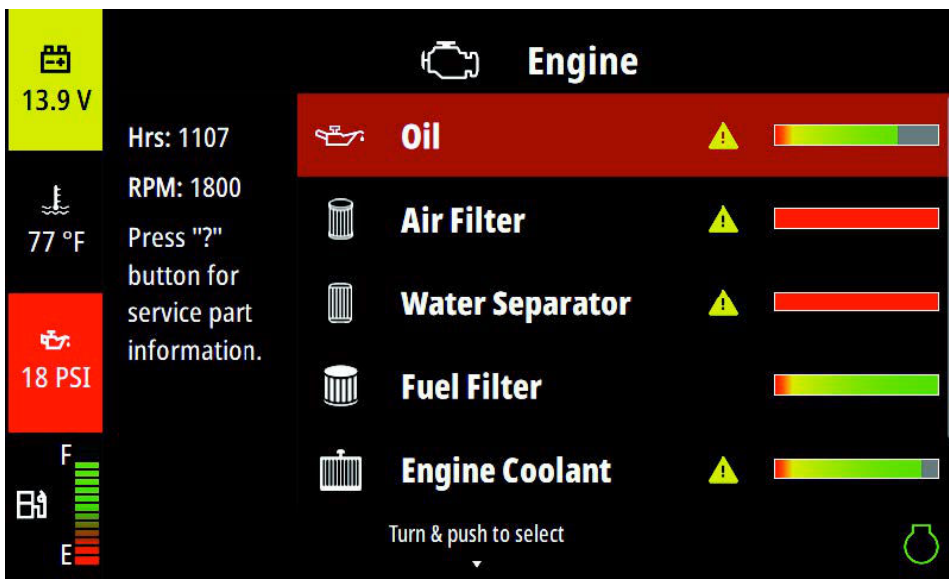

The status bars are based off the recommended service intervals and indicate the remaining time before service is required. A warning indicator will appear if a service item is nearing the end of its service life. The default warning threshold can be configured in the SETTINGS menu.

Green = Normal operation

Yellow = Service is required soon

Red = Service is overdue

To view detailed information about each item, highlight and select the item from the list to display the number of hours remaining before service is required.

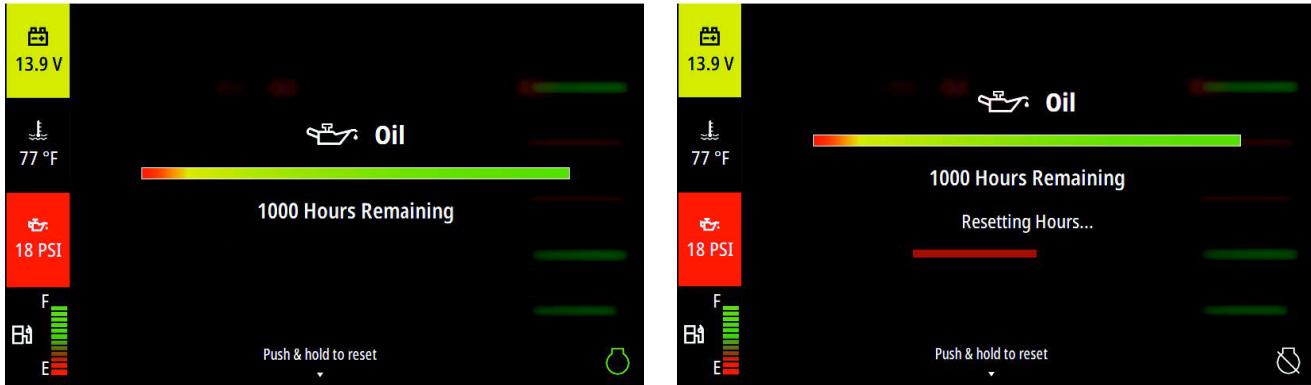

After service has been performed on an item, select it from the list and press and hold the knob for 5 seconds to reset the service indicator.

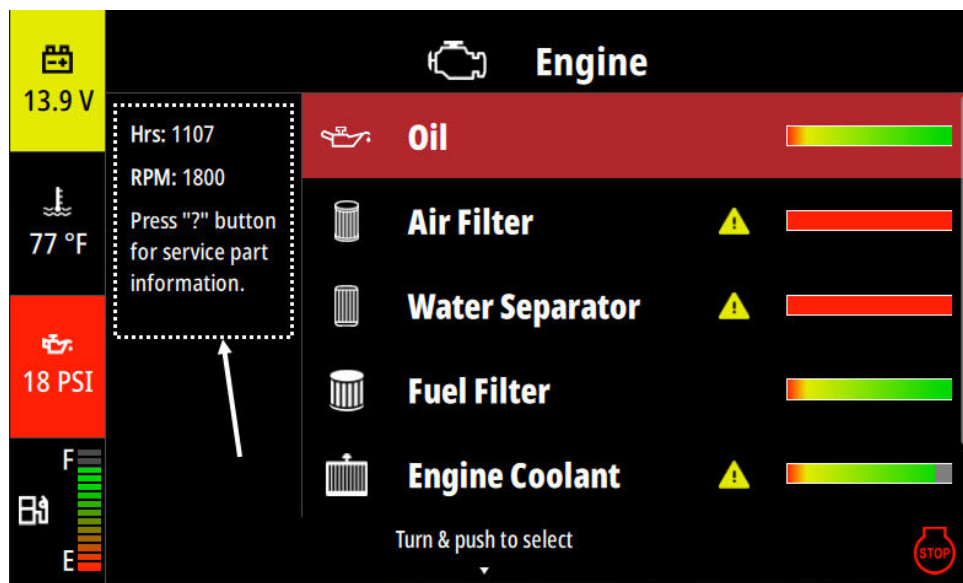

Also within the ENGINE STATUS SCREEN, the engine hours and RPMs can be found near the upper left-hand corner.

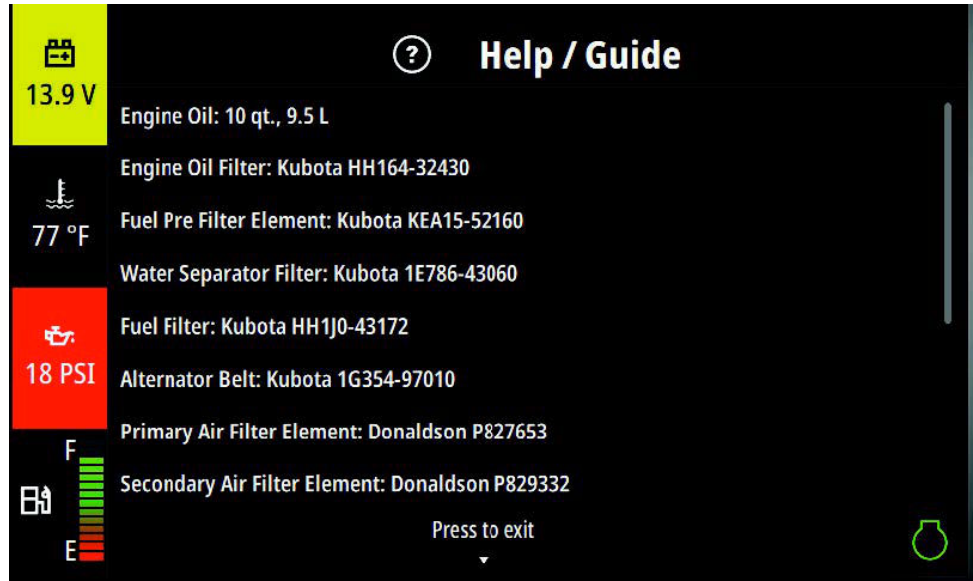

If the HELP (?) button is pressed in this screen, a list of service parts will appear for the engine. The screen can be cleared by pressing the knob.

SETTING SCREEN

The SETTINGS menu allows the operator to customize the machine to their preferences.

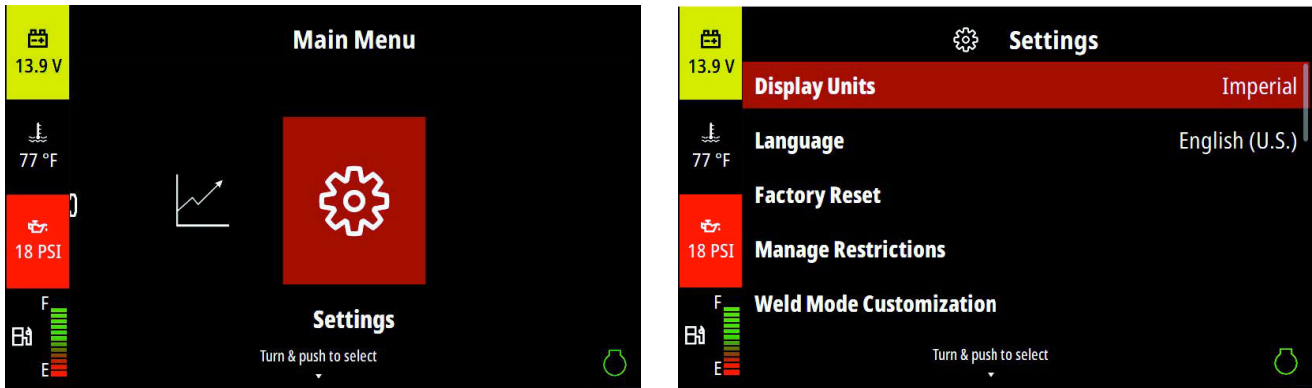

Inside the screen, the additional machine options listed below:

- Display Units - Choose between Imperial and Metric units
- Language - Choose between English, Spanish, or French
- Factory Reset - Restore Factory Default Settings, Reset spool gun, current, and voltage calibrations to factory default.
- Manage Restrictions - Set up or disable Supervisor and Operator PIN numbers (**See MANAGING RESTRICTIONS section**)
- Weld Mode Customization – Enable or disable weld modes depending on preferences
- Engine Service Interval Alerts - Change the percentage of item life remaining before an alert will be displayed
- Clock - Set/Display the local time
- Spool Gun Calibration - Used to calibrate a new spool gun prior to use (**See Spool Gun Calibration section below**).

- Welding Calibration - Used to calibrate welding voltage and current (**See Welding Calibration section below**).
 - Auto-Stop/Start - Enable or Disable the Auto-Stop/Start Function (**See AUTO STOP/START section below**)
- Note:** If Auto Stop/Start is Enabled, options will appear to set the No Load and Standby Periods
- Display Brightness - Adjust the brightness of the display from 5-100%
 - User Interface Timeout - Adjust the time it takes the user interface to shutoff when inactive from 5-120 minutes.
 - Diagnostics Information – Find information about the machine Serial Number, Code Number, K Number, Engine Serial Number, and Machine Hours.
 - Software Version – Check the software version of the User Interface and the Chopper Control Boards
 - Process Selection Assist – When "Process Selection Assist" is activated and a CrossLinc device successfully connects to the machine, the weld mode will automatically adjust based on your connection polarity, (**See Process Selection Assist section page B-16**).

MANAGING RESTRICTIONS

Do not forget the PIN (Personal Identification Number)! The PIN may only be reset by a Lincoln authorized service shop. The MANAGING RESTRICTIONS section of the settings menu may be used to restrict unauthorized access to the machine or operator access to the engine and settings menus. To enable restrictions, first set a Supervisor PIN and then set an Operator PIN. Use the knob to select each digit and press to accept it. To go back to the previous digits use the back button.

SUPERVISOR SECURITY - When the Supervisor PIN is enabled, the ENGINE and SETTING SCREENS may be restricted.

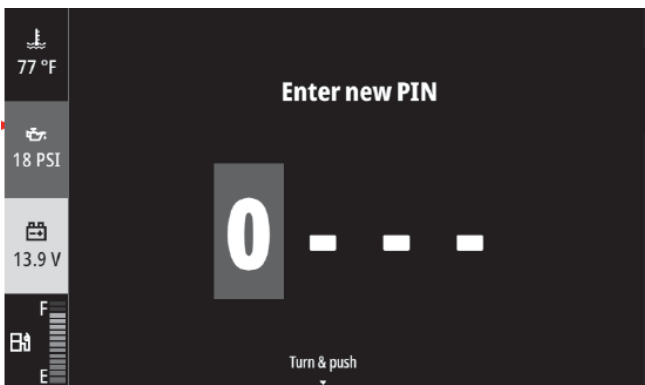
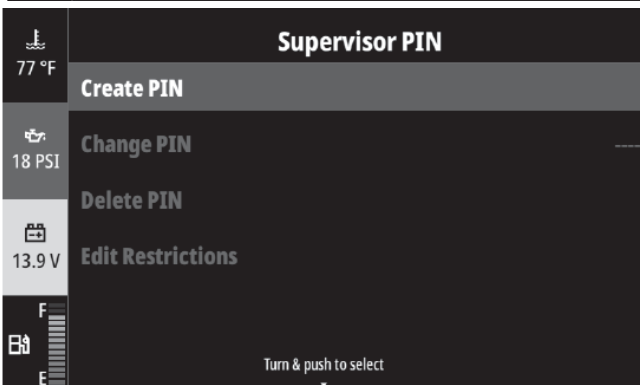
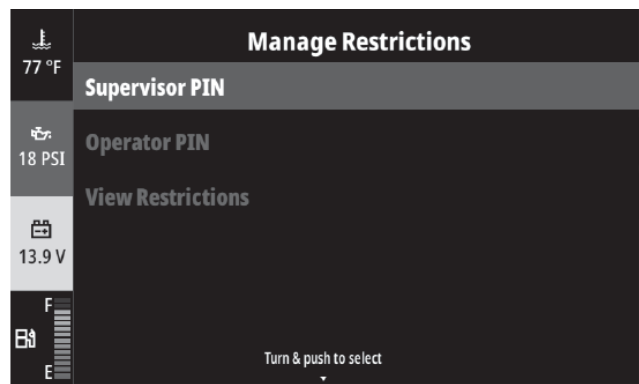
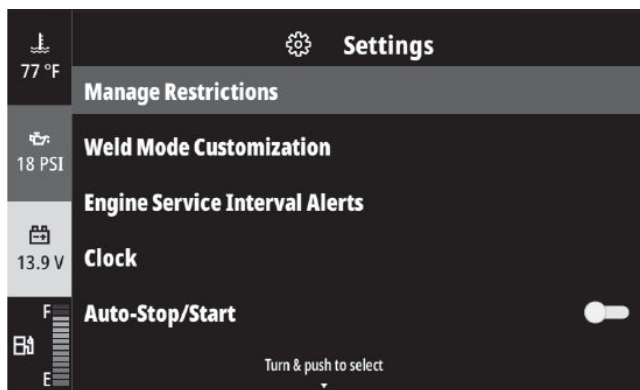

OPERATOR SECURITY - When the Operator PIN is enabled, the user interface will be locked and the generator output will be disabled until the proper PIN has been entered. A time delay may be entered that

OPERATION

will allow the user interface to remain unlocked and the machine to be restarted throughout the day without needing to reenter the PIN.

AUTO-STOP/START

Auto-Stop/Start is a feature that can help save significant fuel costs for users that do not weld continuously. When Auto-Stop/Start is enabled, the machine will automatically shut off the engine after a period of inactivity and remotely restart the engine when needed. To enable and use Auto-Stop/Start:

1. Enable Auto-Stop/Start in the Settings Menu.
2. Set the “No Load Period” (The period of time the engine will remain running without a load).
 - a. Choose from 5 to 120 minutes in the Settings Menu
3. Set the “Standby Period” (The period of time the machine will allow a remote engine start before fully shutting down).
 - a. Choose from 10 to 120 minutes in the Settings Menu
4. A countdown timer appears on the top of the user interface to indicate the remaining time until shutdown.



To restart the engine remotely, tap the stick electrode to the work piece:

STICK ELECTRODE

1. Tap and hold a stick electrode to the work piece for 0.1 to 1 second. Ensure that the electrode makes good electrical contact to the plate.
2. Pull electrode away from work piece and allow the engine to come up to speed.

Note: Auto-Stop/Start will not work and will automatically be disabled if either the electrode is shorted to work when the engine shuts off or if welding electrode-negative polarity and the machine and the work piece share a common earth ground.

Additionally, the engine coolant temperature must be above 140° F (60°C) before the engine will shutdown if Auto- Stop/Start is enabled.

MEMORY MODE OPERATION

The machine features 4 global memories slots, which can be used to save and recall settings. The operator can use the MEMORY SETUP under the WELD MODE settings or the four buttons labelled 1 - 4 along the bottom of the user interface (See below picture).

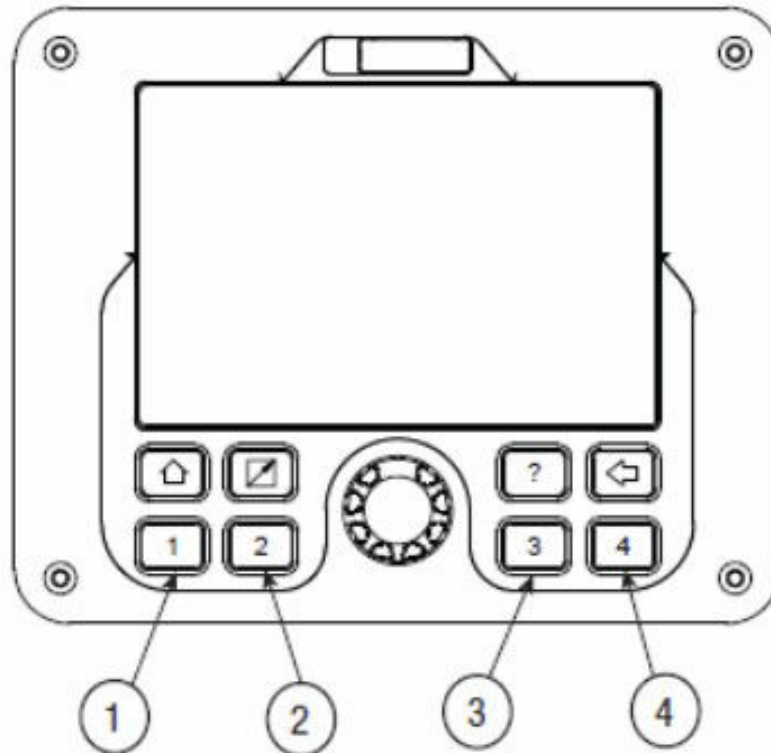

To save a memory, hold the desired memory button until the screen indicates that the memory has been saved.

To recall a memory, press and release the desired memory button.

When a memory is selected, the corresponding memory LED will be lit. If any settings are changed, the LED will go out. The settings will revert to the saved values if the memory button is pressed again.

Note: Memory usage with remote - If a memory is saved with a remote control connected, the remote control must be connected for the memory to function.

PRODUCTIVITY METRICS

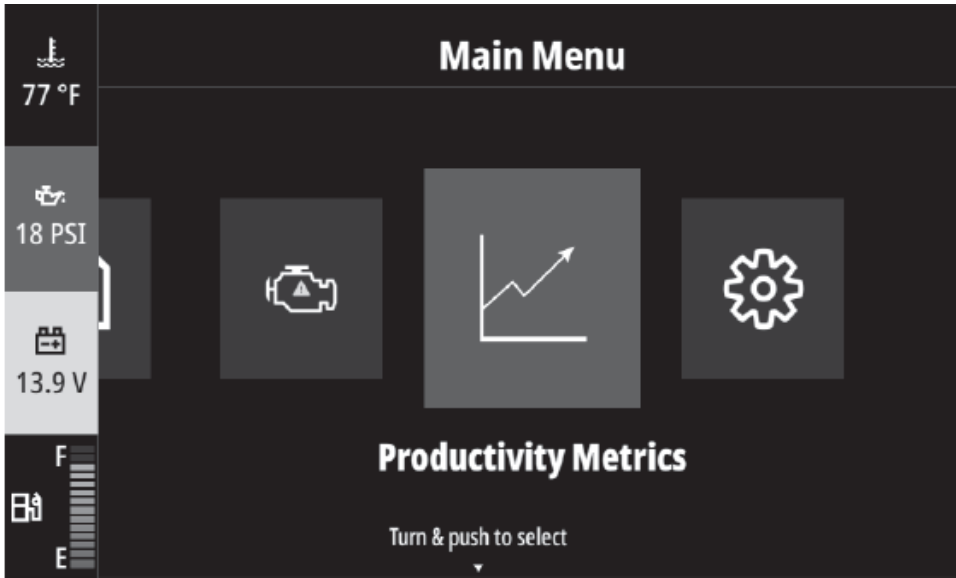

The Productivity Metrics screen provides information and statistics on how the machine is being utilized. Five statistics are monitored:

- **Arc Hours** - Time spent using the machine for welding.
- **Auxiliary Hours** - Time spent using the auxiliary power on the machine.
- **Utilization Percentage** - Represents how efficiently the machine is being used. It shows the percentage of time the machine is being loaded with respect to the total hours on the machine.
- **Standby Hours** - The number of hours the machine is in Standby Mode.
- **Fuel Saved w/ Auto-Start** - The number of US gallons of fuel saved from utilizing the Auto- Stop/Start feature.

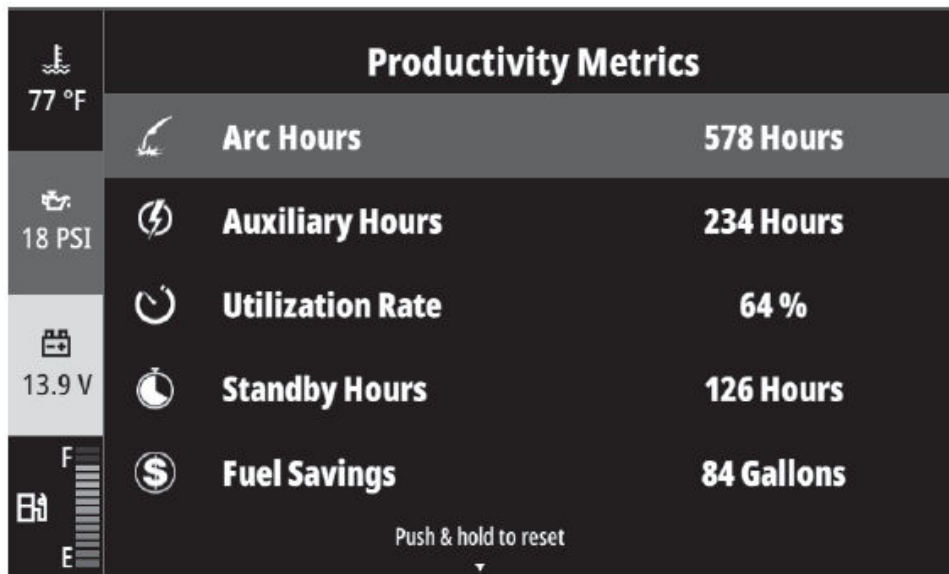

Note: In order to reset any of these metrics, rotate the knob until the desired item is highlighted in red. Then, press and hold the knob on the selected parameter for 5 seconds.

CROSSLINC TECHNOLOGY

This machine has been equipped with CrossLinc® Technology to provide voltage and amperage control at the arc without the need for additional cables. CrossLinc technology allows for remote control of the welding output using the weld cables rather than a separate cable when connected to a CrossLinc compatible wire feeder or remote control.

To start CrossLinc, simply connect a CrossLinc enabled accessory to the machine using the standard weld power cable and the attached the sense lead from the accessory to work piece. When weld output is ON, the CrossLinc accessory will automatically link to the machine, and a CrossLinc indicator light will appear on both the accessory and machine to show active communication. No additional pairing of the machine to the device is needed.

When CrossLinc is active, the remote control is disabled and the CrossLinc device will set values remotely. For Touch Start TIG applications, the machine should be placed on HIGH idle to ensure the most robust CrossLinc connection.

CrossLinc technology uses a communication protocol coupled in the electrode and work cables. For best performance the total voltage drop in the welding loop should be kept under 10V. CrossLinc is not compatible with High Frequency TIG. If high frequency is in the area, the cables need to be routed as far as possible from each other. Also, follow all high frequency best practices, including a driven earth ground.

DUTY CYCLE

Duty cycle is the percentage of time the load is being applied in a 10 minute period. For example, a 60% duty cycle represents 6 minutes of load and 4 minutes of no load in a 10 minute period.

Note: The duty cycles for the IEC rated output and max output are listed on the rating plate of the machine

PARALLELING

When paralleling machines in order to combine their outputs, all units must be operated in a constant current (CC) mode at the same output settings. To achieve this, select the STICK weld mode. Operation in other modes may produce erratic outputs, and large output imbalances between the units.

ARC GOUGING MODE

For optimal performance when arc gouging, select to the GOUGING weld mode and use the knob to adjust output current to the desired level for the gouging electrode being used according to the ratings in the table below.

For optimal performance when arc gouging, it is recommended to set the machine to HIGH IDLE.

Note: If desired the CV-WIRE mode can be used for arc gouging applications.

ELECTRODE DIAMETER	CURRENT RANGE DCEP (+)
1/8" (3.2 mm)	30-60 Amps
5/32" (4.0 mm)	90-150 Amps
3/16" (4.8 mm)	200-250 Amps
1/4" (6.4 mm)	300-400 Amps
5/16" (7.9 mm)	350-450 Amps

Maximum current setting is limited to 400 amps.

STICK (SMAW)

The FRONTIER 400X can be used with a broad range of DC stick electrodes.

The Stick (SMAW) weld mode is designed for horizontal, vertical - up and over head welding with all types of stick electrodes, especially low hydrogen. Once the mode is selected, the output- can be adjust by using the knob located on the user interface.

ARC FORCE sets the short circuit current during stick welding. Increasing the number from -10 (Soft) to +10 (Crisp) increases- the short circuit current and prevents sticking of the electrode to the plate while welding. This can also increase splatter. It is recommended that the ARC FORCE be set to the minimum number without electrode sticking. Start with the knob set at 0.

TIG (GTAW)

The FRONTIER 400X can be used in a wide variety of DC TIG welding applications.

Once TIG (GTAW) mode is selected, the operator has the option to select TOUCH START TIG or SCRATCH START from within the weld settings.

If TOUCH START TIG is selected, to initiate a weld, set the output to the desired current and the tungsten is touched to the work. During the time the tungsten is touching the work, there is very little voltage or current and, in general, this avoids tungsten contamination. Then, the tungsten is gently lifted off the work in a rocking motion, which establishes the arc.

To stop the arc, simply lift the TIG torch away from the work piece. When the arc voltage reaches approximately 30 volts, the arc will go out and the machine will automatically reset to the touch start current level. The tungsten may then be retouched to the work piece to restrike the arc. The arc may also be started and stopped with an amptrol or arc start switch.

Note: While using TOUCH START TIG mode, it is important to use the proper welding cable size to ensure expected performance levels.

If SCRATCH START is selected, the operator can scratch the tungsten against the work to initiate the arc.

Further, the operator can activate pulsed TIG by adjusting the frequency from "OFF" to a value between 0.1-20 Hz will turn on pulse TIG. The frequency changes the number of pulses per second. Pulse TIG can help to minimize burn through on thin materials by reducing the heat input.

If FREQUENCY is ON, the PERCENT PEAK CURRENT setting appears and allows the operator to change percentage of time spent at the peak current vs the background current. The operator can set the value from 5% up to 95%, which affects the amount of heat input into the weld. The default setting is 50%.

FLUX - CORED SELF - SHIELDED WIRE (FCAW - S), SELF - SHIELD GAS - SHIELDED WIRE (FCAW - G), AND MIG (GMAW) MODES

Connect a wire feeder to the FRONTIER 400X and set welder controls according to the instructions listed earlier in this section. The Frontier 400X permits it to be used with a broad range of flux cored wire (Innershield® and Outershield®) electrodes and solid wires for GMAW (MIG) welding. The machine features welding modes precisely tuned for each welding process. Once the welding mode has been selected, the welding can be fine adjusted using the PINCH setting. Turning the PINCH setting clockwise from -10 (soft) to +10 (crisp) changes the arc from soft and washed-in to crisp and narrow. It acts as an inductance control. The proper setting depends on the procedure and operator preference. Start with the knob set at 0

PIPE (SMAW) MODE

****Only available on the Frontier 400X Pipe model****

The pipe (SMAW) weld mode is designed specifically for downhill pipe welding applications to provide superior welding performance for cellulosic and low-hydrogen stick electrodes. Operators can utilize DigFX™ arc tuning controls to adjust for variabilities in the pipe and personal welding techniques.

Once the mode is selected, the output can be adjusted by using the knob located on the user interface. DigFX™ is used to adjust response time of the machine to provide optimal arc and puddle characteristics. This setting provides the user with the ability to fine-tune the machine to fit the electrode, material, joint fit-up, and user technique. By changing the value towards -10 (Soft), the machine will create a softer welding arc with a more fluid puddle and less spatter, which is excellent for fill and cap passes as well as wide gaps. Meanwhile, by changing the value towards +10 (Stiff), the user will experience a stiffer welding arc with more drive and a narrow, fast-freezing puddle, which is excellent for root passes, especially with a tight or closed gap. The factory default setting is 0.

For best welding performance, the mode should be utilized with a 250 ft. (76.2 m) welding loop - 200 ft. (61.0 m) weld cable, 25 ft. (7.6 m) electrode holder, and 25 ft. (7.6 m) ground cable.

AUXILIARY POWER OPERATION

Start the engine and set the RUN / STOP / IDLE switch to the desired operating mode. Full power is available regardless of the welding control settings, if no welding current is being drawn.

The auxiliary power of the FRONTIER 400X consists of two 20 amp 120 VAC (5-20R) duplex receptacles with GFCI protection, one 50 amp 120/240 VAC single phase (14-50R) receptacle and one 50 amp 240 VAC three phase (15-50R) receptacle.

The auxiliary power capacity is 10,000 watts of 60 Hz, single phase power or 11,000 watts of 60 Hz, three phase power. The auxiliary power capacity rating in watts is equivalent to voltamperes at unity power factor. The maximum permissible current of the 240 VAC output is 50 A. The 240 VAC single phase output can be split to provide two separate 120 VAC outputs with a maximum permissible current of 50 A per output to two separate 120 VAC branch circuits. Output voltage is within $\pm 10\%$ at all loads up to rated capacity.

Note: The two 120V GFCI receptacles and the two 120V circuits of the 120/240V receptacle are connected to different phases and cannot be paralleled.

The auxiliary power receptacles should only be used with three wire grounded type plugs or approved double insulated tools with two wire plugs.

The current rating of any plug used with the system must be at least equal to the current capacity of the associated receptacle.

SIMULTANEOUS WELDING AND AUXILIARY POWER LOADS

The auxiliary power capacity previously stated is maintained without any welding load. If a welding load is present, the available auxiliary power will decrease.

simultaneous welding and power loads are specified in the table below. The permissible currents shown assume that current is being drawn from either the 120 VAC or 240 VAC supply (not both at the same time).

OPERATION

Frontier 400X Simultaneous Welding and Power Loads									
Weld Amps		1 PHASE			3 PHASE			Both 1 & 3 PHASE	
		WATTS	AMPS		WATTS	AMPS		WATTS	AMPS
0	PLUS	10,000	42	OR	11,000	27	OR	10,000	-
100		8300	35		8500	20		8300	-
200		5300	22		5700	14		5300	-
250		3500	15		3500	8		3500	-
300		400	2		800	2		400	-
400		0	0		0	0		0	0

FRONTIER 400X EXTENSION CORD LENGTH RECOMMENDATIONS

Current (Amps)	Voltage (Volts)	Load (Watts)	Maximum Allowable Cord Length in ft. (m) for Conductor Size					
			14 AWG	12 AWG	10 AWG	8 AWG	6 AWG	4 AWG
15	120	1800	30 (9)	40 (12)	75 (23)	125 (38)	175 (53)	300 (91)
15	240	3600	60 (18)	75 (23)	150 (46)	225 (69)	350 (107)	600 (183)
20	120	2400	60 (18)	30 (9)	50 (15)	88 (27)	138 (42)	225 (69)
20	240	4800		60 (18)	100 (30)	175 (53)	275 (84)	450 (137)
25	240	6000		90 (27)	150 (46)	225 (69)	250 (76)	
30	240	7200		75 (23)	120 (37)	175 (53)	300 (91)	
38	240	9000		100 (30)	150 (46)	250 (76)		
50	240	12000		125 (38)	250 (61)			

Conductor size is based on maximum 2.0% voltage drop.

ACCESSORIES AND OPTIONS

CROSSLINC ACCESSORIES

LN-25X

True Voltage Technology (TVT) is now included with LN-25X portable wire feeder. When used with a Crosslinc compatible power source, control cables are eliminated and voltage can be controlled right at the feeder. TVT compensates for the voltage drop when using long welding power cables.

Order: K4267-2

ACTIV8X

Rugged, light-weight, portable across-the-arc wire feeder that fits up to an 8" dia. spool. Includes Crosslinc and TVT capability to remotely set voltage from the feeder without a control cable and to ensure the set voltage regardless of power cable lengths.

Order: K3519-1

ACTIV8X Pipe

Ideal pipeline solution for GMAW and FCAW welding applications in a rugged and compact design. Features root-to-cap weld processes - including STT® and Pulsed MIG - specifically optimized for cross country pipe welding.

Order: K4717-1

CROSSLINC REMOTE

Utilized with CrossLinc compatible equipment to control output for CC-processes like stick or TIG welding. Remote control is added in-line with the welding power cable to allow for remote output control of the power source through the weld cable without additional control cables.

Order: K4345-1

GENERAL ACCESSORIES

MEDIUM TWO - WHEEL WELDER TRAILER

Two-wheeled trailer with a Duo-Hitch™ (2" ball and lunette eye combination hitch) for heavy-duty road, off-road, plant, and yard use. For highway use, consult applicable federal, state, and local laws regarding possible additional requirements. Optional fender and light package available.

Order:

K5270-1 Compact Medium Trailer

K5276-1 Fender Kit

K2640-2 Cable Rack

K5278-1 Spare Tire Kit

K5279-1 Fire Extinguisher Bracket / Document Holder

ACCESSORIES AND OPTIONS

Full KVA Power Plug Kit

Provides four 115 VAC plugs rated at 20 amps each, and one dual voltage, full KVA plug- rated at 115/230 VAC, 50 amps.

Order: K802N

Full KVA Adaptor

Provides convenient connection through the full KVA receptacle on engine driven welders for portable power sources needing 240 VAC 1 phase power (NEMA 6-50P).

Order: K1816-1

APEX® System Connector

A field install kit to add 5-pin and 4-pin to the front panel of the machine. Allows for capability with APEX systems for mechanized welding solutions.

Order: K5171-1

User Interface Protective Cover

Installed over the UI to provide extra protection against accidental impacts while on the jobsite or transporting the machine.

Order: K5226-1

Storage Cover

A flame retardant, mildew resistant, and water repellent cover to protect the engine drive when not in use.

Order: K5292-1

SERVICE KITS

Engine Service Kits

One easy-to-purchase kit includes all the needed engine filters to maintain peak welder performance. Includes air filter, fuel filter, oil filter, and fuel water separator.

Order:

K3598-4 Perkins 403F-15T

K3599-5 Kubota D1503-M

REMOTE CONTROLS

REMOTE OUTPUT CONTROL

Portable control provides same dial range as the output control on the welder. The remote features a convenient 12-pin plug for easy connection to the welder.

Order:

K857-2 25ft (7.5M)

K857-3 100ft (30.4M)

REMOTE OUTPUT CONTROL W / 120V RECEPTACLES

Portable control features a convenient 12-pin plug for easy connection to the welder. Includes a detachable control box that can be stowed in a truck or job box to deter job site theft. The control box has a 120V duplex receptacle to power lights, grinders, and other tools right at the arc.

Order: K5312-1 125 ft (38.1 m)

12-PIN TO 6-PIN ADAPTOR

Used to connect 6-pin remotes into the 12-pin connector on the front of the welder.

Order: K2909-1

WIRELESS REMOTE CONTROL

A field installed kit to allow operators to add a wireless remote to the machine to switch between welding processes, adjust welding parameters, recall saved memories, and start/stop the machine from a distance.

Order: K5265-1

TIG ACCESSORIES**PRO-TORCH PTA-26 TIG TOUCH**

Air-cooled 200 amp torch (2 piece) equipped with valve for gas low control with 25 ft. (7.6 m) of cable length. Expendables parts kit available.

Order:

K1783-9 PTA-26 TIG Torch

KP509 Magnum Parts Kit for PTA=26 TIG Torch

FOOT AMPTROL

Remote output control foot pedal for TIG welding with a 25 ft. (7.6 m) cable featuring a 12-pin connector.

Order: K870-2

HAND AMPTROL

Remote output control hand control for TIG welding with a 25 ft. (7.6 m) cable featuring a 12-pin connector. Includes hook and loop straps to secure torch. (One size fits all Pro-Torch TIG Torches.)

Order: K963-4

ARC START SWITCH

ON/OFF switch used for TIG welding when an Amptrol® is not used. Attaches to the TIG torch for convenient finger control - 25 ft. (7.6 m) of cable length.

Order: K814-2

WIRE FEEDER AND GUNS

K126 PRO INNERSHIELD® GUN

Feature replaceable liners, interchangeable backend, long life Magnum® PRO contact tips, improved heat resistant gun tubes, and better trigger lead protection. For self shielded .062-5/64 in. (1.6-2.0 mm) wire with 15 ft. (4.5 m) cable. Includes K466-10 Connector Kit.

Order K126-12

CABLE ACCESSORIES

TWECO® ADAPTORS

Allows for quick cable changeovers on the jobsite.

Order:

- K2487-1 Stud to Tweco Female Adapter - LENCO (CT - 40FS)
- K2946-1 Tweco Style Cam-Lock Adapter Plug for 2/0 (50 mm²) cable
- K3416-70 Tweco Style Plug (Male, 1/0 thru 2/0)
- K3416-90 Tweco Style Plug (Male, 3/0 thru 4/0)
- K3417-70 Tweco Sytle Receptacle (Female, 1/0 thru 2/0)
- K3417-90 Tweco Style Receptacle (Female, 3/0 thru 4/0)

POWER SOURCES

SQUARE WAVE TIG 200

Portable TIG an stick welding machine that provides smooth and stable AC TIG welding on aluminum and DC TIG welding on steel, stainless steel and chrome- moly.

Order: K5126-1

POWERMIG 210MP

Multi-process welder with MIG, stick, TIG, and flux-cored welding. The push-and-turn digital controls and color display screen make setup and operation intuitive and easy, while the all-metal wire drive and sturdy sheet-metal construction make it rugged and ready for any job. Run off auxiliary power to provide an additional welding arc.

Order: K3963-1

TOMAHAWK 1000 PLASMA CUTTER

Cuts metal using the AC generator power from the engine-driven welder. Requires the T12153-10 Full-KVA Power Plug (NEMA 15-50P).

Order: K2808-1

INVERTEC V276

Proven, portable CC power source for Stick or TIG welding featuring digital weld meters. Runs off the auxiliary power to provide an additional welding arc.

Order: K4868-1

MAINTENANCE

SAFETY PRECAUTIONS

READ AND UNDERSTAND ENTIRE SECTION BEFORE OPERATING MACHINE.

WARNING



- Have qualified personnel do all maintenance and troubleshooting work.
- Turn the engine off before working inside the machine or servicing the engine.
- Remove guards only when necessary to perform maintenance and replace them when the maintenance requiring their removal is complete. If guards are missing from the machine, obtain replacements from a Lincoln Distributor.
- Always use the greatest care when working near moving parts.

Read the Safety Precautions in the front of this manual and in the Engine Owner's Manual before working on this machine.

Keep all equipment safety guards, covers, and devices in position and in good repair. Keep hands, hair, clothing, and tools away from the gears, fans, and all other moving parts when starting, operating, or repairing the equipment.

WARNING



HOT PARTS AND FLUID can burn or cause fire.

- Do not touch hot parts with bare hands or allow hot fluid to contact skin.
- Allow equipment to completely cool before servicing.
- Handle hot parts using proper tools and wear heavy insulated welding gloves and clothing to prevent burns.
- Do not place unit on, over, or near combustible surfaces.
- Keep all Flammable material away from unit.

WARNING



Before carrying out service, maintenance and/or repair jobs, fully disconnect power to the machine.

⚠ WARNING



Use Personal Protective Equipment (PPE), including safety glasses, dust mask and gloves to avoid injury. This also applies to persons who enter the work area.

⚠ WARNING



MOVING PARTS can injure.

- Do not operate with doors open or guards off.
- Stop engine before servicing.
- Keep away from moving parts.

⚠ WARNING



Have qualified personnel do all maintenance and troubleshooting work.

ROUTINE AND PERIODIC MAINTENANCE

The below list should be performed daily:

- Check the engine oil level.
- Refill the fuel tank to minimize moisture condensation in the tank.
- Open the water drain valve located on the bottom of the water separator element 1 or 2 turns and allow to drain into a container suitable for diesel fuel for 2 to 3 seconds. Repeat the above drainage procedure until diesel fuel is detected in the container.
- Clean interior of machine with a low pressure air stream. Make a thorough inspection of all components.
- Look for signs of overheating, broken leads, or other obvious problems. Many problems can be uncovered with a good visual inspection.

PERIODIC

Blow out the machine with low pressure air periodically. In particularly dirty locations, this may be required once a week.

BRUSH REMOVAL AND REPLACEMENT

It is normal for the brushes and slip rings to wear and darken slightly. Inspect the brushes when a generator overhaul is necessary.

WARNING

Do not attempt to polish slip rings while the engine is running.

ENGINE MAINTENANCE

Refer to the SERVICE PLAN section of the Engine Operator's Manual for the recommended maintenance schedule of the following:

- a) Engine Oil and Filter
- b) Air Cleaner
- c) Fuel Filter and Delivery System
- d) Alternator Belt
- e) Battery
- f) Cooling System

Refer to the ENGINE SERVICE table for the particular engine (Kubota or Perkins) the welder is equipped with for various engine maintenance components.

AIR FILTER**WARNING**

- Excessive air filter restriction will result in reduced engine life.
- Never use gasoline or low flash point solvents for cleaning the air cleaner element. A fire or explosion could result.
- Never run the engine without the air cleaner. Rapid engine wear will result from contaminants, such as dust and dirt being drawn into the engine.

The diesel engine is equipped with a dry type air filter. Never apply oil to it. Service the air cleaner per instructions on the AIR FILTER SERVICE INSTRUCTIONS.

Replace the air filter element as needed per the service indicator. If no indicator is present, clean as needed and replace every 500 hours of operation. Under dusty conditions, replace sooner.

AIR FILTER SERVICE INSTRUCTIONS

Single- and Two-Stage Engine Air Cleaners

1 REMOVE THE FILTER

Unfasten or unlatch the service cover. Because the filter fits tightly over the outlet tube to create the critical seal, there will be some initial resistance, similar to breaking the seal on a jar. Gently move the end of the filter back and forth to break the seal then rotate while pulling straight out. Avoid knocking the filter against the housing.



Rotate the filter while pulling straight out.

If your air cleaner has a safety filter, replace it every third primary filter change. Remove the safety filter as you would the primary filter. Make sure you cover the air cleaner outlet tube to avoid any unfiltered contaminant dropping into the engine.

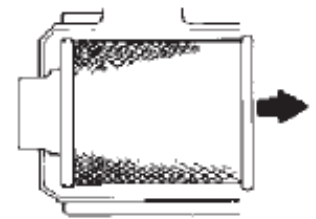

2 Clean Both Surfaces of the Outlet Tube and Check the Vacuator™ Valve

Use a clean cloth to wipe the filter sealing surface and the inside of the outlet tube. Contaminant on the sealing surface could hinder an effective seal and cause leakage. Make sure that all contaminant is removed before the new filter is inserted. Dirt accidentally transferred to the inside of the outlet tube will reach the engine and cause wear. Engine manufacturers say that it takes only a few grams of dirt to "dust" an engine! Be careful not to damage the sealing area on the tube.

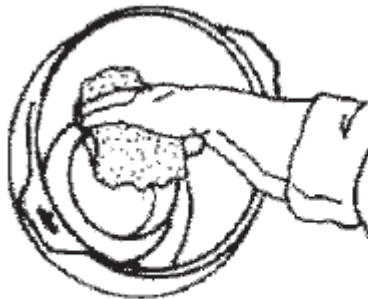

Outer edge of the outlet tube

Wipe both sides of the outlet tube clean.

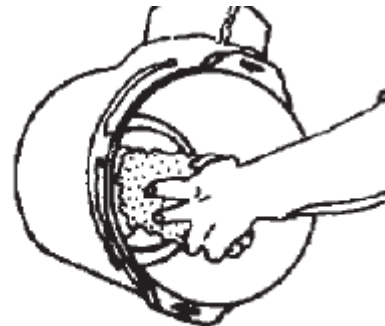

Inner edge of the outlet tube

If your air cleaner is equipped with a Vacuator Valve

Visually check and physically squeeze to make sure the valve is flexible and not inverted, damaged or plugged.



3 Inspect the Old Filter for Leak Clues

Visually inspect the old filter for any signs of leaks. A streak of dust on the clean side of the filter is a telltale sign. Remove any cause of leaks before installing new filter.

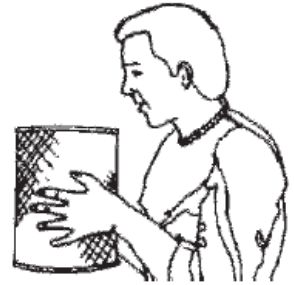

4 Inspect the New Filter for Damage

Inspect the new filter carefully, paying attention to the inside of the open end, which is the sealing area. NEVER install a damaged filter. A new Donaldson radial seal filter may have a dry lubricant on the seal to aid installation.



5 Insert the New Radial Seal Filter Properly

If you're servicing the safety filter, this should be seated into position before installing the primary filter.

Insert the new filter carefully. Seat the filter by hand, making certain it is completely into the air cleaner housing before securing the cover in place. The critical sealing area will stretch slightly, adjust itself and distribute the sealing pressure evenly. To complete a tight seal, apply pressure by hand at the outer rim of the filter, not the flexible center. (Avoid pushing on the center of the urethane end cap.) No cover pressure is required to hold the seal. NEVER use the service cover to push the filter into place! Using the cover to push the filter in could cause damage to the housing, cover fasteners and will void the warranty.

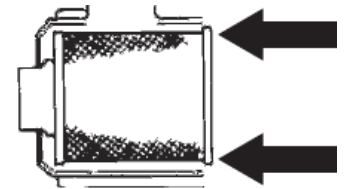

If the service cover hits the filter before it is fully in place, remove the cover and push the filter (by hand) further into the air cleaner and try again. The cover should go on with no extra force.

Once the filter is in place, secure the service cover.

⚠ CAUTION



NEVER use the service cover to push the filter into place! Using the cover to push the filter in could fasteners and will void the warranty.

6 Check Connectors for Tight Fit

Make sure that all mounting bands, clamps, bolts, and connections in the entire air cleaner system are tight. Check for holes in piping and repair if needed. Any leaks in your intake piping will send dust directly to the engine!

FUEL FILTERS

WARNING



When working on the fuel system

- Keep naked lights away, do not smoke!
- Do not spill fuel!

The Frontier 400X is equipped with a fuel pre-filter / water separator before the electric lift pump and a fuel filter after the lift pump and before the injectors. Open the drain on the fuel pre-filter / water separator and drain out any water daily. Close drain when diesel fuel starts to come out. If excessive water is in the fuel, the engine will not start. The procedure for changing the filter is as follows:

1. Close the fuel shutoff valve.
2. Clean the area around the fuel filter head. Remove the filter. Clean the gasket surface of the filter head and replace the o ring.
3. Fill the clean filter with clean fuel, and lubricate the o ring seal with clean lubricating oil.
4. Install the filter as specified by the filter manufacturer.

WARNING



Mechanical over tightened will distort the threads, filter element seal, or filter can.

COOLING SYSTEM

The cooling system of the engine needs to be checked and cleaned periodically. (Consult the Engine Owner's Manual for the proper procedures and frequency).

Coolant needs to be added at the radiator filler neck after removing cap when system is cool. Fill to top of filler neck. Engine will not start if coolant level is too low.

The coolant system is equipped with an internal expansion tank located inside the top radiator tank. This allows for normal thermal expansion and contraction of the engine coolant.

CHECKING AND REPLACING COOLANT

⚠ WARNING



HOT COOLANT can burn skin. Do not remove cap if radiator is hot.

Check the coolant level by observing the level in the radiator. Add 50/50 antifreeze / water solution if the level is low by removing the radiator cap and adding coolant into the radiator. Fill up to the tube in the radiator filler neck.

To drain the coolant, open the valve at the bottom of the radiator. Open the radiator cap to allow complete drainage. (Tighten the valve and refill with a 50/50 antifreeze/water solution) Use an automotive grade (low silicate) ethylene glycol antifreeze. The cooling system capacity is 7.2 qts. (6.8L). Squeeze upper and lower radiator hoses while filling to bleed air from system coolant. Replace and tighten the radiator cap

Periodically remove the dirt from the radiator fins.

Periodically check the fan belt and radiator hoses. Replace if signs of deterioration are found.

⚠ CAUTION



Always premix the antifreeze and clean tap water before adding to the radiator. It is very important that a precise 50/50 solution be used with this engine year round. This gives proper cooling during hot weather and freezing protection to -34° F (-37° C).

Cooling solution exceeding 50% ethylene glycol can result in engine overheating and damage to the engine. Coolant solution must be premixed before adding to radiator.

BATTERY HANDLING

⚠ WARNING



GASES FROM BATTERY can explode.

- keep sparks, flame, and cigarettes away from battery.

 **WARNING**



To prevent EXPLOSION when:

- **INSTALLING A NEW BATTERY** - disconnect negative cable from the old battery first and connect to new battery last.
- **CONNECTING A BATTERY CHARGER** - Remove battery from welder by disconnecting negative cable first, then the positive cable and battery clamp. When reinstalling, connect negative cable last. Keep well ventilated.
- **USING A BOOSTER** - connect the positive lead to the battery first, then connect negative lead to engine foot.

 **WARNING**



BATTERY ACID CAN BURN EYES AND SKIN.

- Wear gloves and eye protection and be careful when working near battery. Follow instructions printed on battery.

PREVENTING ELECTRICAL DAMAGE

1. When replacing, jumping, or otherwise connecting the battery to the battery cables, the proper polarity must be observed. Failure to observe the proper polarity could result in damage to the charging circuit. The positive (+) battery cable has a red terminal cover.
2. If the battery requires charging from an external charger, disconnect the negative battery cable first and then the positive battery cable before attaching the charger leads. Failure to do so can result in damage to the internal charger components. When reconnecting the cables, connect the positive cable first and negative cable last.

PREVENTING BATTERY DISCHARGE -

Turn the RUN/STOP switch to stop when engine is not running.

PREVENTING BATTERY BUCKLING -

Tighten nuts on battery clamp until snug.

CHARGING THE BATTERY -

When you charge, jump, replace, or otherwise connect battery cables to the battery, be sure the polarity is correct. Improper polarity can damage the charging circuit. The Frontier™ 400X positive (+) battery terminal has a red terminal cover.

If you need to charge the battery with an external charger, disconnect the negative cable first, then the positive cable before you attach the charger leads. After the battery is charged, reconnect the positive battery cable first and the negative cable last. Failure to do so can result in damage to the internal charger components.

Follow the instructions of the battery charger manufacturer for proper charger settings and charging time.

ENGINE OIL CHANGE

Drain the engine oil while the engine is warm to assure rapid and complete draining. It is recommended that each time the oil is changed the oil filter be changed as well.

- Be sure the unit is off. Disconnect the negative battery cable to ensure safety.
- Locate oil drain hose and valve in bottom of base and pull through the hole in the battery access panel on the welder.
- Remove the cap from the drain valve. Push valve in and twist counterclockwise. Pull to open and drain the oil into a suitable container for disposal.
- Close the drain valve by pushing in and twisting clockwise. Replace the cap.
- Refill the crankcase to the upper limit mark on the dipstick with the recommended oil. Race and tighten the oil filter cap securely.
- Push oil drain hose and valve back into unit, re-connect negative battery cable, and close doors and engine top cover before restarting unit. Wash your hands with soap and water after handling used motor oil. Please dispose of used motor oil in a manner that is compatible with the environment. We suggest you take it in a sealed container to your local service station or recycling center for reclamation. DO NOT throw it in the trash, pour it on the ground, or down a drain.

SAE 10W-30 oil that meets API class CJ-4 or better is recommended for general, all temperature use, 5F to 104F (-15C to 40C).

See the Engine Owner's Manual for more specific information on oil viscosity recommendations

Oil Filter Change

- Drain the oil.
- Remove the oil filter with an oil filter wrench and drain the oil into a suitable container. Discard the used filter.

Note: Care should be taken during filter removal to not disrupt or damage in any way fuel lines.

- Clean the filter mounting base and coat the gasket of the new filter with clean engine oil.
- Screw the new filter on by hand until the gasket contacts the mounting base. Using an oil wrench, tighten the filter an additional $\frac{1}{2}$ to $\frac{7}{8}$ of a turn.
- Refill the crankcase with the specific amount of the recommended engine oil. Reinstall the oil filler cap and tighten securely.
- Start the engine and check for oil filter leaks.
- Stop the engine and check the oil level. If necessary, add oil to the upper limit mark on the dipstick.

TIGHTENING THE FAN BELT

If the fan belt is loose, the engine can overheat and the battery lose its charge. Check tightness by pressing on the belt midway between the pulleys. For tightness requirements, please refer to the Engine Owner's Manual.

NAMEPLATES/WARNING DECALS MAINTENANCE

Whenever routine maintenance is performed on this machine - or at least yearly - inspect all nameplates and labels for legibility. Replace those which are no longer clear. Refer to the parts list for the replacement item number.

GFCI MODULE

⚠ WARNING



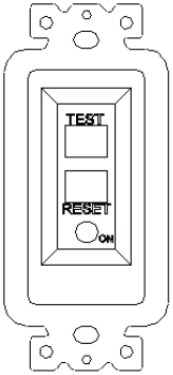
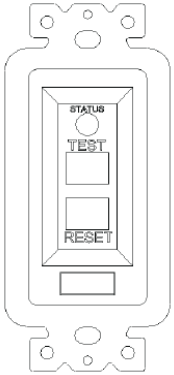

- An electric shock can result in serious injury or death.
- Always perform the GFCI test before using the generator. If the GFCI system fails the test, the machine must be repaired by an authorized service center.
- If the GFCI fails to trip when the test button is pressed (“ON” light does not go off or “STATUS light is RED) or fails to reset (“ON” light does not go on or “STATUS light is blinking) the device is inoperative and should be replaced immediately.
- If the GFCI tests properly without any appliance connected to it but trips each time an appliance is connected to it, the appliance has a ground fault and needs to be repaired or replaced. **DO NOT USE THE APPLIANCE IF THIS CONDITION OCCURS: A REAL SHOCK HAZARD MAY EXIST.**
- Due to the risk of power interruption, do not power life support equipment from this machine.
- GFCI’s do not protect against short circuits or overloads.
- Unplug accessories and tools before attempting service.
- Close the front service doors protecting the receptacles when operating the machine.
- Do not test or reset the GFCI while at idle speed.
- If the LED blinks, stop using the GFCI receptacle and have it replaced by an authorized service center.
- Long extension cords or cords with poor insulation may allow enough leakage current to trip the GFCI.

The GFCI module protects the (2) 120 VAC duplex receptacles. Two different types of modules are used in the Frontier.





Machines manufactured approximately September 2021 or earlier	Machines manufactured approximately October 2021 or later
The GFCI is an auto reset GFCI. It is identified by the “ON” LED located below the buttons.	The GFCI is an auto reset, self-testing GFCI. It is identified by the “STATUS” LED located above the buttons.
	
<ul style="list-style-type: none"> • Auto Reset: Immediately supplies power to the load when power is applied to the line. 	<ul style="list-style-type: none"> Auto Reset: Immediately supplies power to the load when power is applied to the line.
<ul style="list-style-type: none"> • “ON” LED illuminates red when the load has power. 	<ul style="list-style-type: none"> “STATUS” LED illuminates Green when the GFCI is functioning properly.

Machines manufactured approximately September 2021 or earlier	Machines manufactured approximately October 2021 or later
	"STATUS" LED illuminates Red when the GFCI has "tripped". Press the reset button.
	"STATUS" LED illuminates flashing Red when the GFCI has failed and needs replaced.
To test this GFCI, press the "TEST" button. The "ON" red LED should turn off. Then press the "RESET" button. The "ON" red LED should turn on. If the "ON" red LED does not turn off and on as indicated, the GFCI failed the test and should be replaced.	While this GFCI has a self-testing feature, to manually test this GFCI, press the "TEST" button. The "STATUS" LED should turn red. Then press the "RESET" button. The "STATUS" LED should turn green. If the "STATUS" LED does not turn red and green as indicated, or flashes red, the GFCI failed the test and should be replaced.

ENGINE SERVICE KUBOTA D1503-M

KUBOTA D1503- M 24.8 HP www.kubota.com							ENGINE SERVICE			
EVERY DAY OR EVERY 8 HOURS	FIRST SERVICE 50 HOURS	EVERY 100 HOURS OR 3 MONTHS	EVERY 150 HOURS OR 4 MONTHS	EVERY 300 HOURS OR 9 MONTHS	EVERY 400 HOURS OR 12 MONTHS	EVERY 500 HOURS OR 15 MONTHS	EVERY 800 HOURS	ENGINE SERVICE (NOTE 2) MAINTENANCE ITEM	TYPE OR QUANTITY	ICONS
I								COOLANT LEVEL		
					I	I		CONCENTRATION OF ANTIFREZE	50/50 WATER/ETHYLENE GLYCOL	
						C		COOLANT (NOTE 3, 4, 5 & 6)	7.6QT., 7.2L	
I								ENGINE OIL LEVEL (NOTE 1)		
	R		R					ENGINE OIL (NOTE 1 & 3)	5.9QT., 5.6L (INCLUDING FILTER)	
	R		R					ENGINE OIL FILTER	KUBOTA #HH164-32430	
		C						DRAIN WATER SEPARATOR & FUEL STRAINER		
					R			WATER SEPARATOR ELEMENT	Donaldson #P502166 Lincoln #M20840-A	
					R			FUEL FILTER CANISTER	KUBOTA #16631-43560	

MAINTENANCE

KUBOTA D1503- M 24.8 HP www.kubota.com							ENGINE SERVICE			
EVERY DAY OR EVERY 8 HOURS	FIRST SERVICE 50 HOURS	EVERY 100 HOURS OR 3 MONTHS	EVERY 150 HOURS OR 4 MONTHS	EVERY 300 HOURS OR 9 MONTHS	EVERY 400 HOURS OR 12 MONTHS	EVERY 500 HOURS OR 15 MONTHS	EVERY 800 HOURS	ENGINE SERVICE (NOTE 2) MAINTENANCE ITEM	TYPE OR QUANTITY	ICONS
		I						TENSION OF ALTERNATOR DRIVE BELT		
		I						ALTERNATOR DRIVE BELT WEAR		
						R		ALTERNATOR DRIVE BELT	KUBOTA #17480-97010	
		C						AIR FILTER (EARLIER CHECK MAY BE REQUIRED)		
					R			AIR FILTER ELEMENT	DONALDSON # P82286 Lincoln#M19801-1A	
							I	VALVE CLEARANCE	INTAKE 0.0071" - 0.0086" EXHAUST 0.0071" - 0.0086"	
							I	ELECTRICAL SYSTEMS		
							I	ALL NUTS AND BOLTS FOR TIGHTNESS		
I								LEAKS OR ENGINE DAMAGE		
	I	I						BATTERY & ELECTROLTE LEVEL	BCI GROUP 34	
								ENGINE SERVICE KIT	K3599-5	

I = INSPECT C = CLEAN R = REPLACE

Note:





1. Consult Engine Operators Manual for oil recommendations.
2. Consult Engine Operators Manual for additional maintenance schedule information.
3. Fill slowly! Ensure correct quantity is used.
4. Top off with distilled water if level gets low.
5. Clean and flush cooling system every 500 hours.
6. Replace coolant every 24 months.
7. Engine Service Kit includes oil filter, primary and secondary air filters, fuel pre-filter, fuel filter, and water separator filter.

Above operations to be carried out by trained personnel with reference to workshop manual where necessary.



These preventative maintenance periods apply to average conditions of operation. If necessary use shorter periods.

WARRANTY WORK PERFORMED ON THE ENGINE CONTAINED IN THE MACHIONE, IF NOT BILLABLE TO THE ENGINE MANUFACTURER, SHOULD BE PRE- APPROVED BY CALLING THE LINCOLN ELECTRIC COMPANY AT 888-935-3877

ENGINE SERVICE PERKINS 403F-15T

PERKINS 403F-15T www.perkins.com						ENGINE SERVICE		
EVERY DAY OR EVERY 8 HOURS	FIRST SERVICE 20 / 50 HOURS	EVERY 100 HOURS OR 3 MONTHS	EVERY 200 HOURS OR 6 MONTHS	EVERY 500 HOURS OR 12 MONTHS	EVERY 1000 HOURS OR ANNUALLY	ENGINE SERVICE (NOTE 2) MAINTENANCE ITEM	TYPE OR QUANTITY	ICONS
I						COOLANT LEVEL		
			I			CONCENTRATION OF ANTIFREZE	50/50 WATER/ETHYLENE GLYCOL	
					R	COOLANT (NOTE 3)	7.6QT., 7.2L	
I						ENGINE OIL LEVEL (NOTE 1)		
	R			R		ENGINE OIL (NOTE 1 & 3)	6.5QT., 6L (INCLUDING FILTER)	
	R			R		ENGINE OIL FILTER	PERKINS #140517050	
C						DRAIN WATER SEPARATOR & FUEL STRAINER		
				R		WATER SEPARATOR ELEMENT	DONALDSON #P502166 LINCOLN #M20840-A	
				R		FUEL FILTER CANISTER	PERKINS #4429491	
			I			TENSION OF ALTERNATOR DRIVE BELT		
			I			ALTERNATOR DRIVE BELT WEAR		
					R	ALTERNATOR DRIVE BELT	KUBOTA #1G354-97010	

MAINTENANCE

PERKINS 403F-15T www.perkins.com						ENGINE SERVICE		
EVERY DAY OR EVERY 8 HOURS	FIRST SERVICE 20 / 50 HOURS	EVERY 100 HOURS OR 3 MONTHS	EVERY 200 HOURS OR 6 MONTHS	EVERY 500 HOURS OR 12 MONTHS	EVERY 1000 HOURS OR ANNUALLY	ENGINE SERVICE (NOTE 2) MAINTENANCE ITEM	TYPE OR QUANTITY	ICONS
C						AIR FILTER (EARLIER CHECK MAY BE REQUIRED)		
				R		AIR FILTER ELEMENT	DONALDSON # P822686	
					R	RENEW THE ENGINE-BREATHER		
					I	TIGHTEN CYLINDER HEAD	CONTACT KUBOTA	
					I	VALVE CLEARANCE	INTAKE 0.008" EXHAUST 0.008"	
					I	ELECTRICAL SYSTEMS		
					I	ALL NUTS AND BOLTS FOR TIGHTNESS		
					I	INJECTOR PERFORMANCE	CONTACT PERKINS	
I						LEAKS OR ENGINE DAMAGE		
					I	BATTERY	BCI GROUP 34	
					C	CLEAN TURBOCHARGER IMPELLER CASTING AND THE TURBOCHARGER COMPRESSOR CASTING		
						ENGINE SERVICE KIT	K3598-4	

I = INSPECT C = CLEAN R = REPLACE

Note:

1. Consult Engine Operators Manual for oil recommendations.
2. Consult Engine Operators Manual for additional maintenance schedule information.
3. Fill slowly! Ensure correct quantity is used.
4. Engine Service Kit includes oil filter, primary and secondary air filters, fuel pre-filter, fuel filter, and water separator filter.

Above operations to be carried out by trained personnel with reference to workshop manual where necessary.

These preventative maintenance periods apply to average conditions of operation. If necessary use shorter periods.

WARRANTY WORK PERFORMED ON THE ENGINE CONTAINED IN THE MACHIONE, IF NOT BILLABLE TO THE ENGINE MANUFACTURER, SHOULD BE PRE- APPROVED BY CALLING THE LINCOLN ELECTRIC COMPANY AT 888-935-3877

TROUBLESHOOTING

HOW TO USE TROUBLESHOOTING GUIDE

WARNING



Service and Repair should only be performed by Lincoln Electric Factory Trained Personnel. Unauthorized repairs performed on this equipment may result in danger to the technician and machine operator and will invalidate your factory warranty. For your safety and to avoid Electrical Shock, please observe all safety notes and precautions detailed throughout this manual.

This Troubleshooting Guide is provided to help you locate and repair possible machine malfunctions. Simply follow the three-step procedure listed below.

1. LOCATE PROBLEM (SYMPTOM)

Look under the column labeled "PROBLEM (SYMPTOMS)". This column describes possible symptoms that the machine may exhibit. Find the listing that best describes the symptom that the machine is exhibiting.

2. POSSIBLE CAUSE

The second column labeled "POSSIBLE CAUSE" lists the obvious external possibilities that may contribute to the machine symptom.

3. RECOMMENDED COURSE OF ACTION

This column provides a course of action for the Possible Cause, generally it states to contact your local Lincoln Authorized Field Service Facility.

CAUTION



If you do not understand or are unable to perform the Recommended Course of Action safely, contact your local Lincoln Authorized Field Service Facility.

Observe all additional safety guidelines detailed throughout this manual.

FUNCTIONAL PROBLEMS - ENGINE

PROBLEMS (SYMPTOMS)	POSSIBLE CAUSE	RECOMMENDED COURSE OF ACTION
ENGINE PROBLEMS		

TROUBLESHOOTING











PROBLEMS (SYMPTOMS)	POSSIBLE CAUSE	RECOMMENDED COURSE OF ACTION
Engine will not crank	<ol style="list-style-type: none"> 1. Battery low. 2. Check 10A Battery Circuit Breaker 3. Loose battery which may need Inspected, cleaned, cable connections or tightened. 4. Faulty wiring in engine starting circuit. 5. Faulty engine starter. Contact authorized local Engine Service Shop. 	<p>If all recommended possible areas of misadjustment have been checked and the problem persists, Contact your local Lincoln Authorized Field Service Facility.</p>
Engine will crank but not start.	<ol style="list-style-type: none"> 1. Out of fuel. 2. Fuel shut off valve is in the off position make sure the valve lever is in the open position 3. Fuel Filter or water separator element dirty/clogged. 4. High coolant temperature or low oil pressure. 	
Engine shuts down shortly after starting.	<ol style="list-style-type: none"> 1. Low oil pressure. Check oil level (Consult engine service dealer). 2. High coolant temperature. Check engine cooling system. 3. Faulty oil pressure switch. 4. Faulty coolant temperature switch. Contact authorized local Engine Service shop. 5. Check coolant level. 	
Engine shuts down while under a load.	<ol style="list-style-type: none"> 1. High coolant temperature. 2. Machine output limits exceeded. 	
Engine runs rough.	<ol style="list-style-type: none"> 1. Dirty fuel. 2. Water in fuel. 3. Air Filter may need to be cleaned. 	
Engine will not shut off.	<ol style="list-style-type: none"> 1. Faulty Idler Switch. 2. Faulty EGC Relay. 	
Battery does not stay charged.	<ol style="list-style-type: none"> 1. Faulty battery. 2. Faulty engine alternator. 3. Loose or broken lead in charging circuit. 4. Loose fan belt may need tightening. 	
Engine will not idle down to low speed.	<ol style="list-style-type: none"> 1. Idler switch in HIGH idle position, make sure switch is set to AUTO. 2. Faulty Idler Switch. 3. Faulty Idle Relay. 	
<p>E-2 Engine will not go to high idle when attempting to weld.</p>	<ol style="list-style-type: none"> 1. Poor work lead connection to work. Poor lead connections to machine. 2. Welding output is OFF. (No open circuit voltage at output 	

FUNCTIONAL PROBLEMS GENERAL















PROBLEMS (SYMPTOMS)	POSSIBLE CAUSE	RECOMMENDED COURSE OF ACTION
FUNCTIONAL PROBLEMS		
Engine goes to low idle but does not stay at low idle.	<ol style="list-style-type: none"> 1. Faulty Idle Relay. 2. Intermittent Auxiliary load 3. Remote trigger input is present. 	<p>If all recommended possible areas of misadjustment have been checked and the problem persists, Contact your local Lincoln Authorized Field Service Facility.</p>
No welding output or auxiliary output.	<ol style="list-style-type: none"> 1. Broken lead in rotor circuit. 2. Faulty field bridge diode. 3. Faulty rotor. 	
Welder has some/ no output and no control. Auxiliary output OK	<ol style="list-style-type: none"> 1. Faulty remote kit. 2. Faulty output control potentiometer. 3. Faulty output control wiring. 	
No welding output. Auxiliary output OK.	<ol style="list-style-type: none"> 1. Output terminals may be set to Remote in the settings. 	
No auxiliary power.	<ol style="list-style-type: none"> 1. Open breakers may need to be reset. 2. GFCI tripped. 3. Faulty breaker(s), receptacle, or GFCI. 4. Faulty auxiliary circuit wiring. 	

GRAPHIC SYMBOL DESCRIPTIONS

GRAPHIC SYMBOLS USED IN THE MANUAL OR BY THIS MACHINE

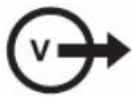
SYMBOL	DESCRIPTION	SYMBOL	DESCRIPTION
	INPUT POWER	U_0	OPEN CIRCUIT VOLTAGE
	ON	U_p	PEAK VOLTAGE
	OFF	U_1	INPUT VOLTAGE
	HIGH TEMPERATURE	U_2	OUTPUT VOLTAGE
	CIRCUIT BREAKER	I_1	INPUT CURRENT
	POSITIVE OUTPUT	I_2	OUTPUT CURRENT
	NEGATIVE OUTPUT		PROTECTIVE GROUND
	INPUT POWER CONNECTION		WARNING OR CAUTION

GRAPHIC SYMBOL DESCRIPTIONS

SYMBOL	DESCRIPTION	SYMBOL	DESCRIPTION
	SINGLE PHASE		EXPLOSION
	DIRECT CURRENT		DANGEROUS VOLTAGE
	ALTERNATING CURRENT		SHOCK HAZARD
	DIRECT AND ALTERNATING CURRENT		TIG TORCH
	FAULT		STICK ELECTRODE HOLDER
	OUTPUT ACTIVE		REFER TO OPERATOR'S MANUAL
	REMOTE		1 PHASE INVERTER POWER SOURCE

RETEST AFTER REPAIR

Service and repair should be performed by only Lincoln Electric factory trained personnel. Unauthorized repairs performed on this equipment may result in danger to the technician or machine operator and will invalidate your factory warranty. For your safety and to avoid electrical shock, please observe all safety notes and precautions detailed throughout this manual.

If for any reason you do not understand the test procedures or are unable to perform the test/repairs safely, contact the Lincoln Electric Service Department for electrical troubleshooting assistance before you proceed. Call 1-888-935-3877.

TEST DESCRIPTION

Retest a machine:

- If it is rejected under test for any reason that requires you to remove any mechanical part which could affect the machine's electrical characteristics.

OR

- If you repair or replace any electrical components.

ENGINE OUTPUT				
ENGINE MODE		NO LOAD RPM	LOAD RPM	
Low Idle		1440 RPM	N/A	
High Idle		1800 RPM	1800 RPM	
WELDER DC OUTPUT (STICK)				
WELD MODE	OUTPUT CONTROL	OPEN CIRCUIT VOLTAGE	LOAD VOLTAGE	LOAD AMPS
Stick (CC)	Maximum	55-60 VDC	36-38 VDC	400 Amps
WELDER CV OUTPUT (WIRE FEEDING)				
WELD MODE	OUTPUT CONTROL	OPEN CIRCUIT VOLTAGE	LOAD VOLTAGE	
Constant Voltage (MIG)	Maximum	55 - 60 VDC	10 - 45 VDC	
TOUCH START TIG OUTPUT				
WELD MODE	OUTPUT CONTROL	LOAD VOLTAGE	LOAD AMP	
TIG	Maximum	18-22 VDC	5 - 400 Amps	
AUXILIARY POWER OUTPUT				
OPEN CIRCUIT VOLTAGE		LOAD AMP	WATTS (CONTINUOUS)	
1240 VAC 3-Phase		50 Amps	11,000	
240 VAC 1-Phase		50 Amps	10,000	
120 VAC 1-Phase		20 Amps	10,000	

DIMENSIONS

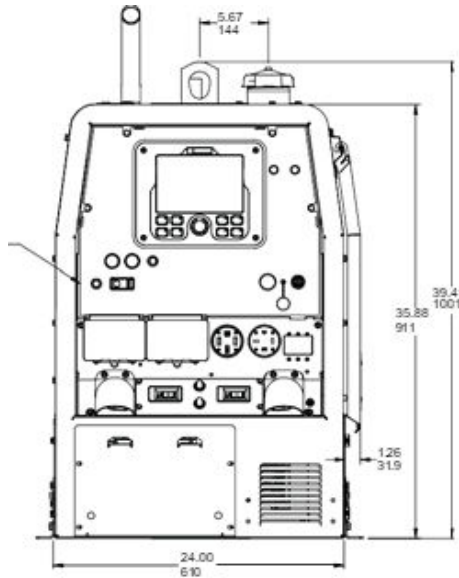
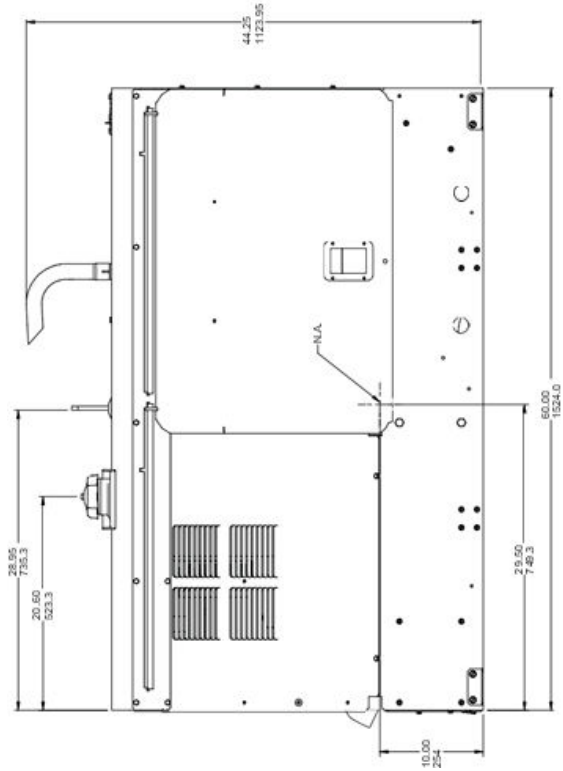
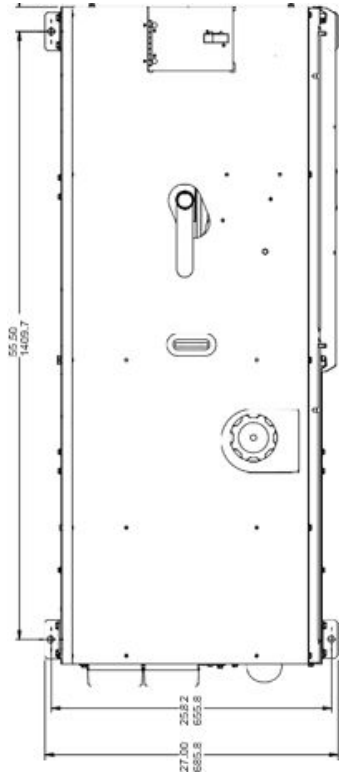

N.A. CENTER OF GRAVITY WITH OIL IN ENGINE,
 COOLANT IN RADIATOR, AND EMPTY FUEL TANK
 N.B. CASEFRONT GRAPHICS MAY NOT MATCH ALL
 CODES

SCHEMATIC DIAGRAMS

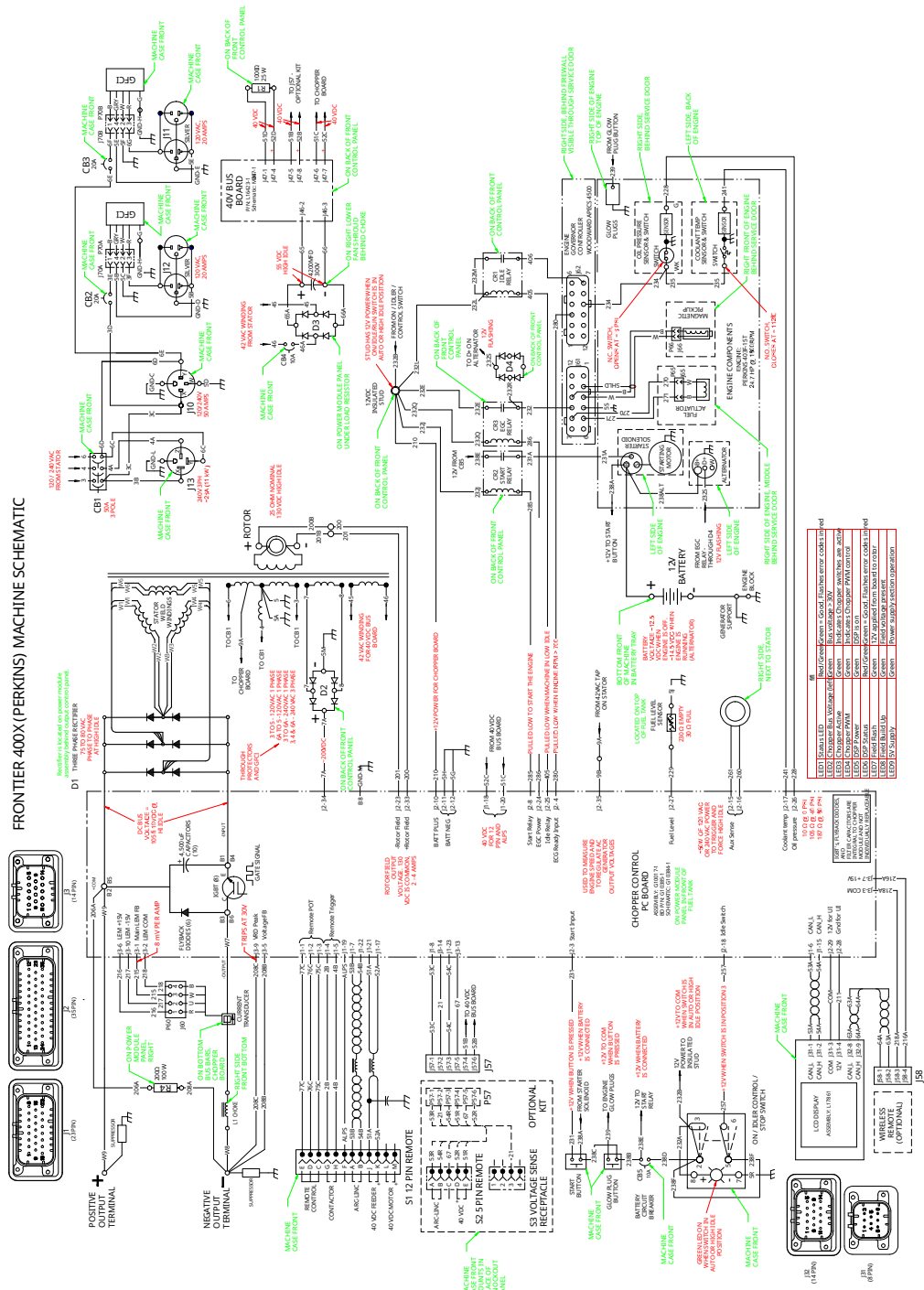

CUSTOMER ASSISTANCE POLICY

CUSTOMER ASSISTANCE POLICY

The business of Lincoln Electric is manufacturing and selling high quality welding equipment, automated welding systems, consumables, and cutting equipment. Our challenge is to meet the needs of our customers, who are experts in their fields, and to exceed their expectations. On occasion, purchasers may ask Lincoln Electric for information or technical information about their use of our products. Our employees respond to inquiries to the best of their ability based on information and specifications provided to them by the customers and the knowledge they may have concerning the application. Our employees, however, are not in a position to verify the information provided or to evaluate the engineering requirements for the particular weldment, or to provide engineering advice in relation to a specific situation or application. Accordingly, Lincoln Electric does not warrant or guarantee or assume any liability with respect to such information or communications. Moreover, the provision of such information or technical information does not create, expand, or alter any warranty on our products. Any express or implied warranty that might arise from the information or technical information, including any implied warranty of merchantability or any warranty of fitness for any customers' particular purpose or any other equivalent or similar warranty is specifically disclaimed.

Lincoln Electric is a responsive manufacturer, but the definition of specifications, and the selection and use of specific products sold by Lincoln Electric is solely within the control of, and remains the sole responsibility of the customer. Many variables beyond the control of Lincoln Electric affect the results obtained in applying these types of fabrication methods and service requirements.

WELD FUME CONTROL EQUIPMENT

The operation of welding fume control equipment is affected by various factors including proper use and positioning of the equipment, maintenance of the equipment and the specific welding procedure and application involved. Worker exposure level should be checked upon installation and periodically thereafter to be certain it is within applicable OSHA PEL and ACGIH TLV limits.

PARTS LIST

Content/Details may be changed or updated without notice. For most current Instruction Manuals, go to PARTS.LINCOLNELECTRIC.COM.

